



Accessories

Contents

	Page
Bestsellers _____	3–5
System components _____	6–41
bottBoxes and service cases _____	42–97
Load restraint _____	98–137
Accessories _____	138–179





Bestsellers



vario3

perfo panels with hook kit



- Kit 16-piece
- 1 perfo perforated panel width 457 x height 990 mm
- 5 Hooks D 75 mm
- 5 Hooks D 100 mm
- 5 Hooks D 150 mm
- 1 perfo spanne

Replace ** with the number of your desired colour.



.11
gentian blue
RAL 5010

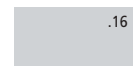

.16
light grey
RAL 7035



.24
crimson red
RAL 3004



.19
anthracite grey
RAL 7016

Dimensions W x H [mm]	990 x 457
Weight [kg]	5.00
Order ref.	14030154.**V

Tiltbox with lashing straps



- Ideal for vehicles with bott in-vehicle equipment including lashing components and/or lashing rails
- The use of lashing straps with fittings allows transported goods to be secured in a fast and reliable way by means of the lashing points or lashing rails of the vehicle
- Set consisting of:
 - 1 bott TiltBox
 - 2 Lashing strap 3.5 m with fitting (-oo-) and cam buckle
 - 2 Lashing strap 3.5 m with fitting (-oo-) and ratchet
 - Including important information on load restraint

Dimensions W x D x H [mm]	304 x 147 x 196
Weight [kg]	2.66
Order ref.	72610040.19V



Bestsellers

Adjustable shoring pole plus



- Used to secure large items in transit
- Telescopic bar can be shortened or extended quickly without tools
- Simple operation by means of Twist Lock when inserting.
- Shoring pole is not spring loaded so there is never any clamping force applied to the roof or the side wall
- Suitable for horizontal and vertical applications
- Equal contact area across the entire length
- Continuous, uniform diameter of the clamping bar that always ensures flat contact surface with transported goods
- Circumferential rubber coating for increased slip-resistance as well as additional protection for the load.

Shoring pole length [mm]	650-800	800-1100	1000-1500	1400-2100	1700-2500
Blocking capacity BC [daN]	650 - 500 daN	700 - 600 daN	725 - 400 daN	500 - 275 daN	425 - 175 daN
Weight [kg]	1.82	2.26	2.84	3.71	4.29
Order ref.	85001118	85001119	85001120	85001121	85001122

Swivel hook



- For installation in the SLF groove system, or for free installation in the vehicle
- The swivel hook does not project beyond the front shelf height when swivelled in
- Swivel hook with rotation to left/right/centre
- Optimum protection for the loaded goods thanks to rubber-coated surface, anti-slip and noise-damping
- Different support depths 91 mm/ 141 mm
- Load capacity support depth 91 mm: 10 kg
- Load capacity support depth 141 mm: 8 kg
- Zinc-plated with rubber coating
- RAL 6018



Dimensions W x D x H [mm]	29 x 123 x 126	29 x 173 x 126
Weight [kg]	0.13	0.17
Order ref.	73003005.17V	73003006.17V



Bestsellers

Internal ladder holder



- For installation on the roof liner to save space in the vehicle
- Suitable for ladders with a length of 2 m, a maximum total step depth of 180 mm and a weight up to 20 kg
- Extension kit can be ordered for ladder lengths of more than 2 metres
- Adjustment to ladder length possible
- Both ladder holder brackets can be folded upwards if not used
- Material: aluminium / painted steel



Version	Internal ladder holder	Extension kit
Dimensions W x D x H [mm]	210 x 1810 x 120	-
Weight [kg]	8.50	1.00
Order ref.	73508060.19V	73508061.19V

Headache rack for flatbeds



- Additional cab protection with flatbeds
- Fixed pin left/right
- Support for long items
- Colour: anthracite grey (RAL 7016) zinc-plated and painted
- Black plastic caps



Version	Volkswagen T6	VW Crafter / MAN TGE
Dimensions W x D x H [mm]	1906 x 120 x 1275	2014 x 120 x 1505
Weight [kg]	34.40	37.10
Order ref.	73520001.19V	73520002.19V

Find the right divider material fast

The size of the drawers in your bott vario3 van racking system follows a fixed grid-type system. This allows you to select matching divider material with ease. Just proceed as follows:

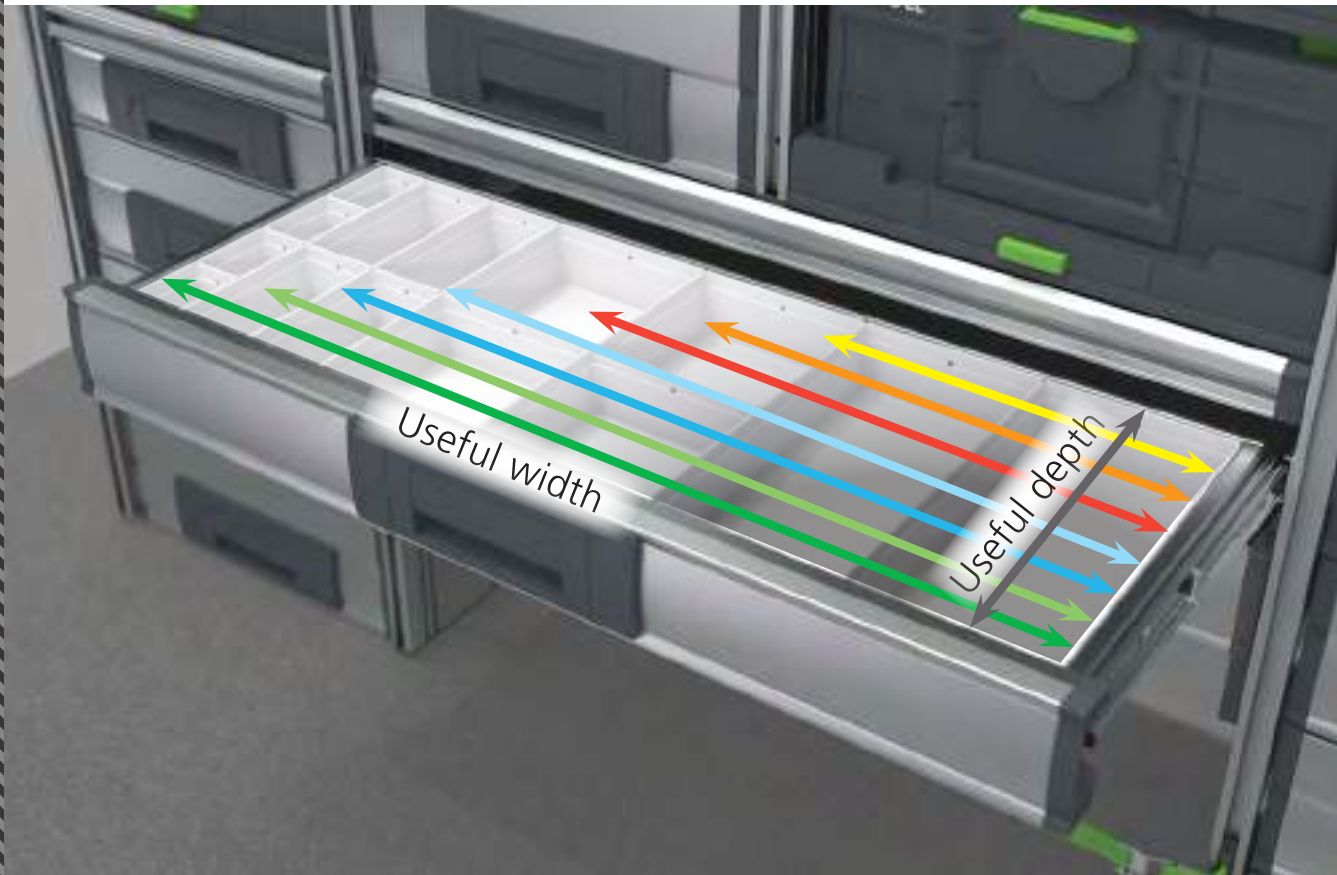

Note on heights

The height of your outer drawer front is decisive for the corresponding dividers and inserts. The respective product tables in this brochure therefore list the front height of the drawer. Please note that the front height of the drawer is used to select the appropriate product and does not correspond to the actual height of the dividers and inserts. This is listed separately.

Our small parts boxes are available in a standard height of 68 mm. They fit perfectly in our drawers with a front height of 100 mm (as well as with the extended front height of 125 mm). They are only suitable to a limited extent for drawers with a higher front height.

Step 1: Measure width

First, measure the clear **width** of the drawer body to determine the system width. This is indicated by the numbers 3 to 10 in the width table below. Now you can see where to find the relevant products in the brochure.

Useful width dimensions (mm)	System width	Page
250	3	9–11
350	4	12–15
475	5	15–19
700	7	19–21
800	8	22–23
925	9	24–26
1025	10	27–29

Step 2: Measure depth

Using the measured **depth** of your drawer, you can determine the system depth (from 3 to 12) using the table below. You will achieve optimum load restraint using divider material that fills out the entire depth of your drawer.

Useful depth dimensions	System depth
300	3
400	4
500	5
700	7
950	9
1300	12

Drawers

3 | 250mm |

Drawer divider kit insert

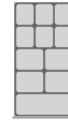

System width	-3	-3
System depth	/4	/5
Dimensions W x D [mm]	366 x 488	366 x 600
Box height [mm]	73	73
Order ref.	73020137.16V	73020138.16V

Divider kit with small parts storage boxes

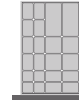
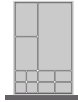

System width	-3	-3
System depth	/4	/4
Dimensions W x D [mm]	366 x 488	366 x 488
Box height [mm]	68	68
Front height of drawer [mm]	100	100
Order ref.	73020038.16V	73020039.16V

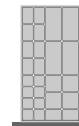
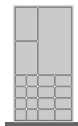

System width	-3	-3
System depth	/5	/5
Dimensions W x D [mm]	366 x 600	366 x 600
Box height [mm]	68	68
Front height of drawer [mm]	100	100
Order ref.	73020040.16V	73020041.16V

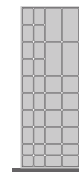
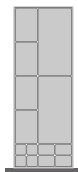

System width	-3	-3
System depth	/7	/7
Dimensions W x D [mm]	366 x 824	366 x 824
Box height [mm]	68	68
Front height of drawer [mm]	100	100
Order ref.	73020105.16V	73020106.16V

Drawer dividers

3 | 250mm |

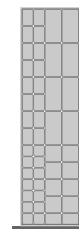
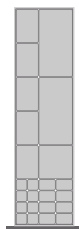

System width	-3	-3
System depth	/9	/9
Dimensions W x D [mm]	366 x 1048	366 x 1048
Box height [mm]	68	68
Front height of drawer [mm]	100	100
Order ref.	73020042.16V	73020043.16V

Divider kit

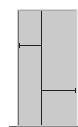
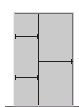

System width	-3			
System depth	/4		/5	
Front height of drawer [mm]	100	150	100	150
Dimensions W x D [mm]	366 x 488		366 x 600	
Height of cross dividers [mm]	75	125	75	125
Order ref.	73020044.19V	73020045.19V	73020046.19V	73020047.19V

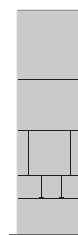
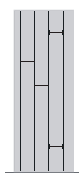

System width	-3			
System depth	/7		/9	
Front height of drawer [mm]	100	150	100	150
Dimensions W x D [mm]	366 x 824		366 x 1048	
Height of cross dividers [mm]	75	125	75	125
Order ref.	73020101.19V	73020102.19V	73020048.19V	73020049.19V

Drawers

3 | 250mm |

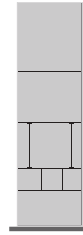
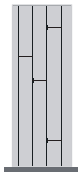

System width	-3			
System depth	/7		/9	
Front height of drawer [mm]	100	150	100	150
Dimensions W x D [mm]	366 x 824		366 x 1048	
Height of cross dividers [mm]	75	125	75	125
Order ref.	73020101.19V	73020102.19V	73020048.19V	73020049.19V

Divider kit sorting boxes



System width	-3	-3
System depth	/5	/7
Dimensions W x D [mm]	366 x 600	366 x 824
Box height [mm]	121	121
Order ref.	73020119.19V	73020120.19V



System width	-3	-3
System depth	/9	/12
Dimensions W x D [mm]	366 x 1048	366 x 1384
Box height [mm]	121	121
Order ref.	73020121.19V	73020122.19V

Drawers

4 | 350mm

Drawer divider kit insert



System width	-4	-4
System depth	/3	/4
Dimensions W x D [mm]	478 x 376	478 x 488
Box height [mm]	73	73
Order ref.	73020139.16V	73020140.16V

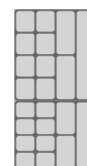
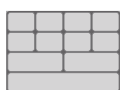

System width	-4	-4
System depth	/5	/7
Dimensions W x D [mm]	478 x 600	478 x 824
Box height [mm]	73	73
Order ref.	73020141.16V	73020144.16V

Divider kit with small parts storage boxes



System width	-4	-4
System depth	/3	/3
Dimensions W x D [mm]	478 x 376	478 x 376
Box height [mm]	68	68
Front height of drawer [mm]	100	100
Order ref.	73020001.16V	73020002.16V

Drawers

4 | 350mm

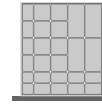
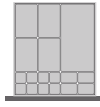

System width	-4	-4
System depth	/4	/4
Dimensions W x D [mm]	478 x 488	478 x 488
Box height [mm]	68	68
Front height of drawer [mm]	100	100
Order ref.	73020003.16V	73020004.16V

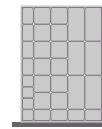
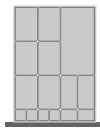

System width	-4	-4
System depth	/5	/5
Dimensions W x D [mm]	478 x 600	478 x 600
Box height [mm]	68	68
Front height of drawer [mm]	100	100
Order ref.	73020005.16V	73020006.16V

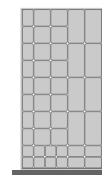
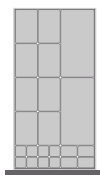

System width	-4	-4
System depth	/7	/7
Dimensions W x D [mm]	478 x 824	478 x 824
Box height [mm]	68	68
Front height of drawer [mm]	100	100
Order ref.	73020107.16V	73020108.16V

Drawer dividers

4 | 350mm



System width	-4	-4
System depth	/9	/12
Dimensions W x D [mm]	478 x 1048	478 x 1348
Box height [mm]	68	68
Front height of drawer [mm]	100	100
Order ref.	73020007.16V	73020008.16V

Divider kit



System width	-4			
System depth	/3		/4	
Front height of drawer [mm]	100	150	100	150
Dimensions W x D [mm]	478 x 376		478 x 488	
Height of cross dividers [mm]	75	125	75	125
Order ref.	73020050.19V	73020051.19V	73020052.19V	73020053.19V



System width	-4			
System depth	/5		/7	
Front height of drawer [mm]	100	150	100	150
Dimensions W x D [mm]	478 x 600		478 x 824	
Height of cross dividers [mm]	75	125	75	125
Order ref.	73020054.19V	73020055.19V	73020103.19V	73020104.19V

Drawers

4 | 350mm



System width	-4			
System depth	/9		/12	
Front height of drawer [mm]	100	150	100	150
Dimensions W x D [mm]	478 x 1048		478 x 1384	
v	75	125	75	125
Order ref.	73020056.19V	73020057.19V	73020058.19V	73020059.19V

Divider kit sorting boxes



System width	-4	
System depth	/5	/7
Dimensions W x D [mm]	478 x 600	478 x 824
Box height [mm]	121	121
Order ref.	73020123.19V	73020124.19V



System width	-4	
System depth	/9	/12
Dimensions W x D [mm]	478 x 1048	478 x 1384
Box height [mm]	121	121
Order ref.	73020125.19V	73020126.19V

Drawer dividers

4 | 350mm

Custom tool shape cut-outs made by hand



- Clear arrangement of tools, unique definition of storage locations and contents, missing parts are spotted immediately, cut-outs can be precisely made with the aid of the cutter set in a few simple steps
- Material: Base: XPE 33, thickness 5 mm Inlay: PE 30, thickness 22 mm
- Colour: Base: red Inlay: black
- Properties: PE 30 laminated, heat-resistant up to 112 °C, non-combustible, resistant to oils, petrol and detergents, environmentally friendly

System width	-4	
System depth	/3	/4
Dimensions W x D x H [mm]	478 x 376 x 27	478 x 488 x 27
Weight [kg]	0.16	0.21
Order ref.	73017001.10V	73017002.10V

5 | 475mm

Drawer divider kit insert

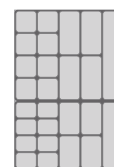
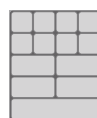
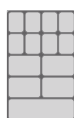

System width	-5	-5	-5
System depth	/3	/4	/7
Dimensions W x D [mm]	590 x 376	590 x 488	590 x 824
Box height [mm]	73	73	73
Order ref.	73020142.16V	73020143.16V	73020145.16V

Drawer dividers

5 |————— 475mm ———|

Divider kit with small parts storage boxes

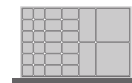
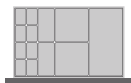

System width	-5	-5
System depth	/3	/3
Dimensions W x D [mm]	590 x 376	590 x 376
Box height [mm]	68	68
Front height of drawer [mm]	100	100
Order ref.	73020009.16V	73020010.16V

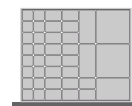
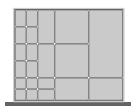

System width	-5	-5
System depth	/4	/4
Dimensions W x D [mm]	590 x 488	590 x 488
Box height [mm]	68	68
Front height of drawer [mm]	100	100
Order ref.	73020011.16V	73020012.16V

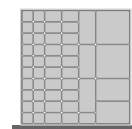
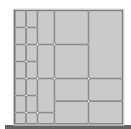

System width	-5	-5
System depth	/5	/5
Dimensions W x D [mm]	590 x 600	590 x 600
Box height [mm]	68	68
Front height of drawer [mm]		100
Order ref.	73020013.16V	73020014.16V

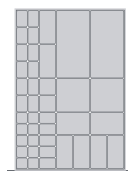

System width	-5
System depth	/7
Dimensions W x D [mm]	590 x 824
Box height [mm]	68
Order ref.	73020113.16V

Drawer dividers

5 | 475mm

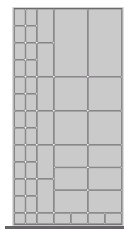

System width	-5
System depth	/9
Dimensions W x D [mm]	590 x 1048
Box height [mm]	68
Front height of drawer [mm]	100
Order ref.	73020015.16V

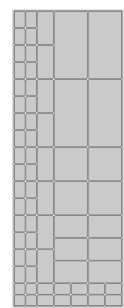

System width	-5
System depth	/12
Dimensions W x D [mm]	590 x 1384
Box height [mm]	68
Front height of drawer [mm]	100
Order ref.	73020016.16V

Divider kit

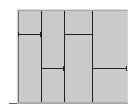

System width	-5			
System depth	/3		/4	
Front height of drawer [mm]	100	150	100	150
Dimensions W x D [mm]	590 x 376		590 x 488	
Height of cross dividers [mm]	75	125	75	125
Order ref.	73020060.19V	73020061.19V	73020062.19V	73020063.19V

5 | 475mm

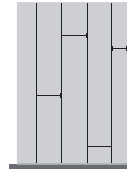
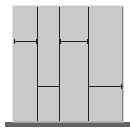

System width	-5			
System depth	/5		/7	
Front height of drawer [mm]	100	150	100	150
Dimensions W x D [mm]	590 x 600		590 x 824	
Height of cross dividers [mm]	75	125	75	125
Order ref.	73020064.19V	73020065.19V	73020111.19V	73020112.19V

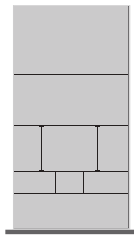

System width	-5		
System depth	/9		
Front height of drawer [mm]	100	150	
Dimensions W x D [mm]	590 x 1048		
Height of cross dividers [mm]	75	125	
Order ref.	73020066.19V	73020067.19V	

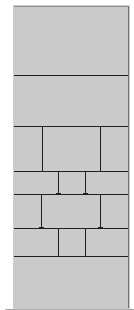

System width	-5		
System depth	/12		
Front height of drawer [mm]	100	150	
Dimensions W x D [mm]	590 x 1384		
Height of cross dividers [mm]	75	125	
Order ref.	73020068.19V	73020069.19V	

Drawers

5 | 475mm

Divider kit sorting boxes

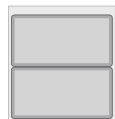

System width	-5	-5
System depth	/5	/7
Dimensions W x D [mm]	590 x 600	590 x 824
Box height [mm]	121	121
Order ref.	73020127.19V	73020128.19V



System width	-5	-5
System depth	/9	/12
Dimensions W x D [mm]	590 x 1048	590 x 1384
Box height [mm]	121	121
Order ref.	73020129.19V	73020130.19V



Drawer dividers

5 |————— 475mm —————|

Custom tool shape cut-outs made by hand



- Clear arrangement of tools, unique definition of storage locations and contents, missing parts are spotted immediately, cut-outs can be precisely made with the aid of the cutter set in a few simple steps
- Material: Base: XPE 33, thickness 5 mm Inlay: PE 30, thickness 22 mm
- Colour: Base: red Inlay: black
- Properties: PE 30 laminated, heat-resistant up to 112 °C, non-combustible, resistant to oils, petrol and detergents, environmentally friendly

System width	-5	
System depth	/3	/4
Dimensions W x D x H [mm]	590 x 376 x 27	590 x 488 x 27
Weight [kg]	0.21	0.27
Order ref.	73017003.10V	73017004.10V

7 |————— 700mm —————|

Divider kit with small parts storage boxes

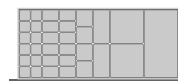

System width	-7	-7
System depth	/3	/3
Dimensions W x D [mm]	814 x 376	814 x 376
Box height [mm]	68	68
Front height of drawer [mm]	100	100
Order ref.	73020017.16V	73020018.16V

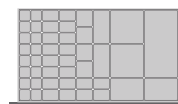
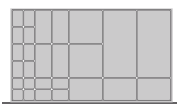

System width	-7	-7
System depth	/4	/4
Dimensions W x D [mm]	814 x 488	814 x 488
Box height [mm]	68	68
Front height of drawer [mm]	100	100
Order ref.	73020019.16V	73020020.16V

Drawer dividers

7 | 700mm

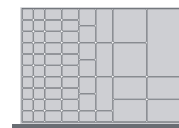
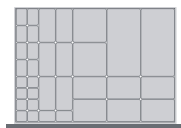

System width	-7	-7
System depth	/5	/5
Dimensions W x D [mm]	814 x 600	814 x 600
Box height [mm]	68	68
Front height of drawer [mm]	100	100
Order ref.	73020093.16V	73020094.16V

Divider kit

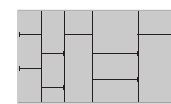
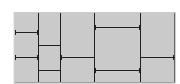

System width	-7			
System depth	/3		/4	
Front height of drawer [mm]	100	150	100	150
Dimensions W x D [mm]	814 x 376		814 x 488	
Height of cross dividers [mm]	75	125	75	125
Order ref.	73020070.19V	73020071.19V	73020072.19V	73020073.19V

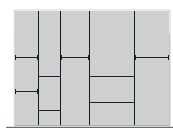

System width	-7	
System depth	/5	
Front height of drawer [mm]	100	150
Dimensions W x D [mm]	814 x 600	
Height of cross dividers [mm]	75	125
Order ref.	73020097.19V	73020098.19V

Drawers

7 |————— 700mm —————|

Divider kit sorting boxes

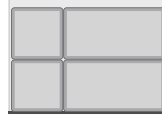

System width	-7
System depth	/5
Dimensions W x D [mm]	814 x 600
Box height [mm]	121
Order ref.	73020131.19V

8 |————— 800mm —————|

Divider kit with small parts storage boxes

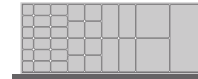

System width	-8	-8
System depth	/3	/3
Dimensions W x D [mm]	926 x 376	926 x 376
Box height [mm]	68	68
Front height of drawer [mm]	100	100
Order ref.	73020021.16V	73020022.16V

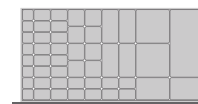
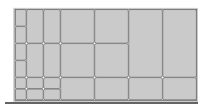

System width	-8	-8
System depth	/4	/4
Dimensions W x D [mm]	926 x 488	926 x 488
Box height [mm]	68	68
Front height of drawer [mm]	100	100
Order ref.	73020023.16V	73020024.16V

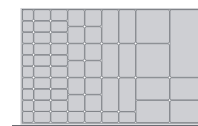
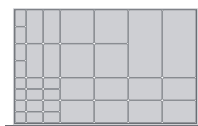

System width	-8	-8
System depth	/5	/5
Dimensions W x D [mm]	926 x 600	926 x 600
Box height [mm]	68	68
Front height of drawer [mm]	100	100
Order ref.	73020095.16V	73020096.16V

Drawer dividers

8

Divider kit

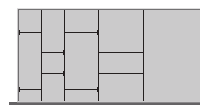

System width	-8			
System depth	/3		/4	
Front height of drawer [mm]	100	150	100	150
Dimensions W x D [mm]	926 x 376		926 x 488	
Height of cross dividers [mm]	75	125	75	125
Order ref.	73020074.19V	73020075.19V	73020076.19V	73020077.19V

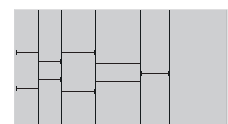

System width	-8		
System depth	/5		
Front height of drawer [mm]	100	150	
Dimensions W x D [mm]	926 x 600		
Height of cross dividers [mm]	75	125	
Order ref.	73020099.19V	73020100.19V	

Divider kit sorting boxes



System width	-8
System depth	/5
Dimensions W x D [mm]	926 x 600
Box height [mm]	121
Order ref.	73020132.19V

Drawer dividers

9 |  925mm

Divider kit with small parts storage boxes

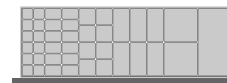

System width	-9	-9
System depth	/3	/3
Dimensions W x D [mm]	1038 x 376	1038 x 376
Box height [mm]	68	68
Front height of drawer [mm]	100	100
Order ref.	73020025.16V	73020026.16V

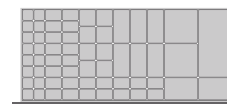
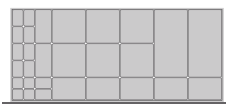

System width	-9	-9
System depth	/4	/4
Dimensions W x D [mm]	1038 x 488	1038 x 488
Box height [mm]	68	68
Front height of drawer [mm]	100	100
Order ref.	73020027.16V	73020028.16V

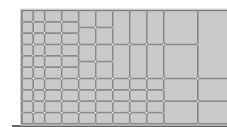
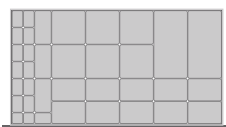

System width	-9	-9
System depth	/5	/5
Dimensions W x D [mm]	1038 x 600	1038 x 600
Box height [mm]	68	68
Front height of drawer [mm]	100	100
Order ref.	73020029.16V	73020030.16V

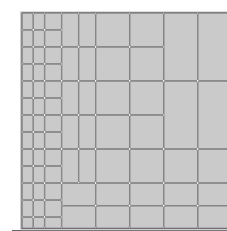
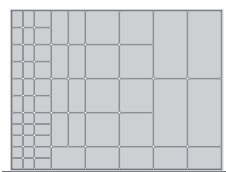

System width	-9	-9
System depth	/7	/9
Dimensions W x D [mm]	1038 x 824	1038 x 1048
Box height [mm]	68	68
Front height of drawer [mm]	100	100
Order ref.	73020114.16V	73020031.16V

Drawer dividers

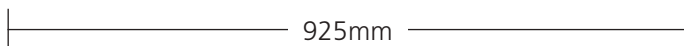
9

Divider kit

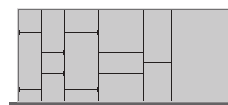
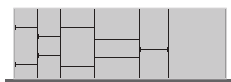

System width	-9			
System depth	/3		/4	
Front height of drawer [mm]	100	150	100	150
Dimensions W x D [mm]	1038 x 376		1038 x 488	
Height of cross dividers [mm]	75	125	75	125
Order ref.	73020078.19V	73020079.19V	73020080.19V	73020081.19V

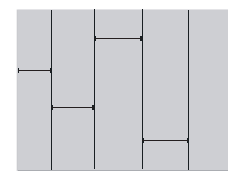
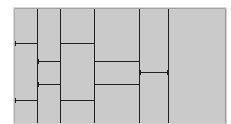

System width	-9			
System depth	/5		/7	
Front height of drawer [mm]	100	150	100	150
Dimensions W x D [mm]	1038 x 600		1038 x 824	
Height of cross dividers [mm]	75	125	75	125
Order ref.	73020082.19V	73020083.19V	73020109.19V	73020110.19V

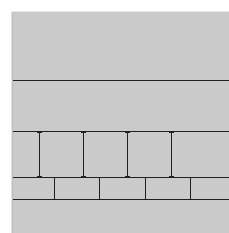

System width	-9			
System depth	/9			
Front height of drawer [mm]	100		150	
Dimensions W x D [mm]	1038 x 1048			
Height of cross dividers [mm]	75		125	
Order ref.	73020084.19V		73020085.19V	

Drawers



Divider kit sorting boxes

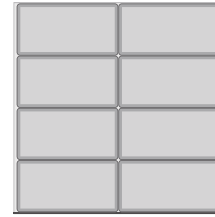
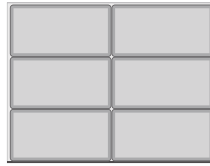
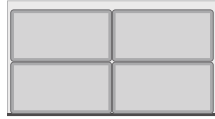

System width	-9	-9	-9
System depth	/5	/7	/9
Dimensions W x D [mm]	1038 x 600	1038 x 824	1038 x 1048
Box height [mm]	121	121	121
Order ref.	73020133.19V	73020134.19V	73020135.19V

Custom tool shape cut-outs made by hand

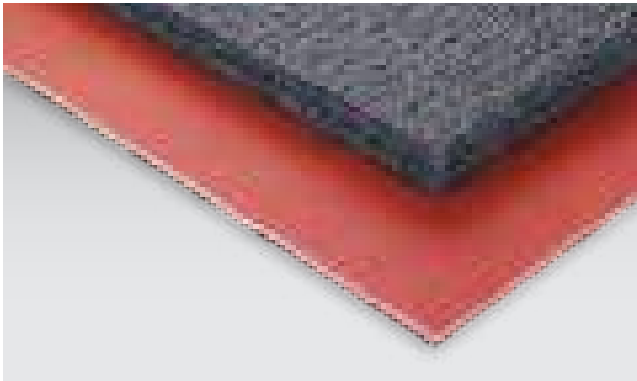

- Clear arrangement of tools, unique definition of storage locations and contents, missing parts are spotted immediately, cut-outs can be precisely made with the aid of the cutter set in a few simple steps
- Material: Base: XPE 33, thickness 5 mm Inlay: PE 30, thickness 22 mm
- Colour: Base: red Inlay: black
- Properties: PE 30 laminated, heat-resistant up to 112 °C, non-combustible, resistant to oils, petrol and detergents, environmentally friendly

System width	-9	
System depth	/3	/4
Dimensions W x D x H [mm]	1038 x 376 x 27	1038 x 488 x 27
Weight [kg]	0.39	0.52
Order ref.	73017005.10V	73017006.10V

Drawer dividers

10

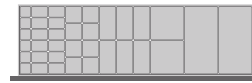
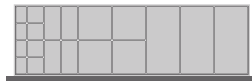

Divider kit with small parts storage boxes

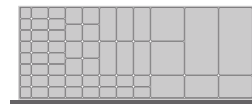

System width	-10	-10
System depth	/3	/3
Dimensions W x D [mm]	1150 x 376	1150 x 376
Box height [mm]	68	68
Front height of drawer [mm]	100	100
Order ref.	73020032.16V	73020033.16V

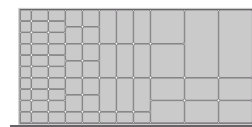
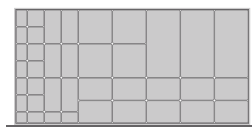

System width	-10	-10
System depth	/4	/4
Dimensions W x D [mm]	1150 x 488	1150 x 488
Box height [mm]	68	68
Front height of drawer [mm]	100	100
Order ref.	73020034.16V	73020035.16V



System width	-10	-10
System depth	/5	/5
Dimensions W x D [mm]	1150 x 600	1150 x 600
Box height [mm]	68	68
Front height of drawer [mm]	100	100
Order ref.	73020036.16V	73020037.16V

Drawer dividers



Divider kit

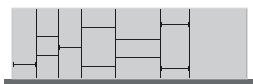

System width	-10			
System depth	/3		/4	
Front height of drawer [mm]	100	150	100	150
Dimensions W x D [mm]	1150 x 376		1150 x 488	
Height of cross dividers [mm]	75	125	75	125
Order ref.	73020086.19V	73020087.19V	73020088.19V	73020089.19V

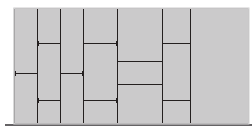

System width	-10	
System depth	/5	
Front height of drawer [mm]	100	150
Dimensions W x D [mm]	1150 x 600	
Height of cross dividers [mm]	75	125
Order ref.	73020090.19V	73020091.19V

Divider kit sorting boxes



System width	-10
System depth	/5
Dimensions W x D [mm]	1150 x 600
Box height [mm]	121
Order ref.	73020136.19V

Drawer dividers

10 |————— 1025mm —————|

Custom tool shape cut-outs made by hand



- Clear arrangement of tools, unique definition of storage locations and contents, missing parts are spotted immediately, cut-outs can be precisely made with the aid of the cutter set in a few simple steps
- Material: Base: XPE 33, thickness 5 mm Inlay: PE 30, thickness 22 mm
- Colour: Base: red Inlay: black
- Properties: PE 30 laminated, heat-resistant up to 112 °C, non-combustible, resistant to oils, petrol and detergents, environmentally friendly

System width	-10	
System depth	/3	/4
Dimensions W x D x H [mm]	1150 x 376 x 27	1150 x 488 x 27
Weight [kg]	0.44	0.58
Order ref.	73017007.10V	73017008.10V

Customising foam inserts by hand



- 3 Cutters with protective covers 1x width 20 mm, 1x width 50 mm, 1x semicircular, 20 x 20 x 80 mm
- Incl. cutter knife
- Folding rule

Dimensions W x D x H [mm]	225 x 170 x 45
Weight [kg]	0.37
Order ref.	13017001.10V

Storage tray for drawers

Storage shelf for drawers

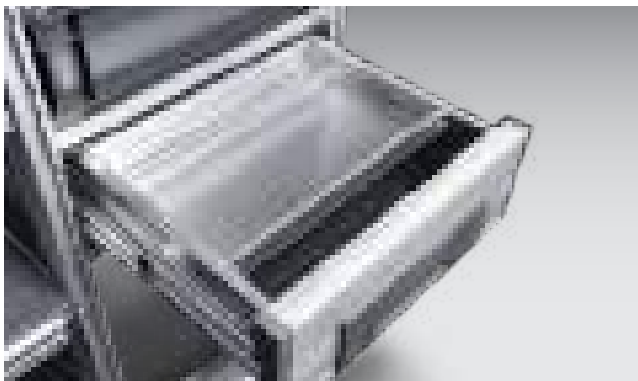

- Suspended tray that sits on the sides of the drawer pan
- To create a second level
- Removable

Version	Crosswise		
System width	-3	-4	-5
Dimensions W x D x H [mm]	366 x 238 x 36	478 x 238 x 36	590 x 238 x 36
Weight [kg]	0.28	0.36	0.47
Assembled/packed	Packed		
Order ref.	72533166.98V	72533167.98V	72533168.98V

Version	Lengthwise		
System depth [mm]	/3	/4	/5
Dimensions W x D x H [mm]	238 x 376 x 44	238 x 488 x 44	238 x 600 x 44
Weight [kg]	0.32	0.41	0.50
Assembled/packed	Packed		
Order ref.	72533169.98V	72533170.98V	72533171.98V

Custom tool shape cut-outs made by hand for drawers



- Clear arrangement of tools, unique definition of storage locations and contents, missing parts are spotted immediately, cut-outs can be precisely made with the aid of the cutter set in a few simple steps
- Material: Base: XPE 33, thickness 5 mm Inlay: PE 30, thickness 22 mm
- Colour: Base: red Inlay: black
- Properties: PE 30 laminated, heat-resistant up to 112 °C, non-combustible, resistant to oils, petrol and detergents, environmentally friendly

Dimensions W x D x H [mm]	505 x 233 x 27
Weight [kg]	0.16
Order ref.	73017009.10V

Storage tray for drawers

Small part storage box kit for drawer storage tray



- For vario3 drawer storage shelf with drawer widths -3, -4, -5 and minimum 175 mm front height
- Optimal fit for drawer width -5, some small part storage boxes for drawer widths -3 and -4 are obsolete
- Small part storage box height 68 mm
- PS, RAL 7035 light grey

Dimensions W x D [mm]	475 x 225
Box height [mm]	68
Order ref.	73020118.16V

Desk panel for drawers



- Foldable thanks to hinges on the drawer body
- Can be used from drawer width -3, system depth /4 and drawer height 100 mm
- Opening angle approx. 100°
- Can also be used for deeper (depth >/4) and wider (width >-4) drawers
- Drawer below remains fully operable
- Natural aluminium / painted steel anthracite grey

System width	-3	-4	-5
System depth	/4		
Dimensions W x D x H [mm]	290 x 432 x 10	402 x 432 x 10	514 x 432 x 10
Weight [kg]	0.78	0.86	0.94
Order ref.	73508068.98V	73508069.98V	73508070.98V

System width	> -5	
System depth	/4	
Dimensions W x D x H [mm]	514 x 432 x 10	
Weight [kg]	1.84	1.94
Order ref.	73508071.98V	73508072.98V

Anti-slip mats for drawers

Anti-slip mat for drawers



- For storing sensitive parts
- Thickness 2.5 mm
- Pack of 5
- Material: robust, tear-resistant PES glass fibre fabric with PVC coating both sides
- Anti-slip, dimensionally stable, impermeable, resistant to oil and grease, washable up to 60°
- Colour: anthracite grey (RAL 7016)

System width	-3				
System depth	/4	/5	/7	/9	/12
Dimensions W x D x H [mm]	366 x 488 x 3	366 x 600 x 3	366 x 824 x 3	366 x 1048 x 3	366 x 1384 x 3
Weight [kg]	0.35	0.40	0.55	0.80	1.10
Assembled/packed	Packed				
Order ref.	71301009.19V	71301010.19V	71301135.19V	71301011.19V	71301142.19V

System width	-4		
System depth	/3	/4	/5
Dimensions W x D x H [mm]	478 x 376 x 3	478 x 488 x 3	478 x 600 x 3
Weight [kg]	0.35	0.50	0.60
Assembled/packed	Packed		
Order ref.	71301012.19V	71301013.19V	71301014.19V

System width	-4		
System depth	/7	/9	/12
Dimensions W x D x H [mm]	478 x 824 x 3	478 x 1048 x 3	478 x 1384 x 3
Weight [kg]	0.80	1.10	1.55
Assembled/packed	Packed		
Order ref.	71301136.19V	71301015.19V	71301016.19V

System width	-5		
System depth	/3	/4	/5
Dimensions W x D x H [mm]	590 x 376 x 3	590 x 488 x 3	590 x 600 x 3
Weight [kg]	0.45	0.60	0.75
Assembled/packed	Packed		
Order ref.	71301017.19V	71301018.19V	71301019.19V

Anti-slip mats for drawers

System width	-5		
System depth	/7	/9	/12
Dimensions W x D x H [mm]	590 x 824 x 3	590 x 1048 x 3	590 x 1384 x 3
Weight [kg]	1.05	1.45	2.00
Assembled/packed	Packed		
Order ref.	71301137.19V	71301020.19V	71301021.19V

System width	-7		
System depth	/3	/4	/5
Dimensions W x D x H [mm]	814 x 376 x 3	814 x 488 x 3	814 x 600 x 3
Weight [kg]	0.70	0.90	1.10
Assembled/packed	Packed		
Order ref.	71301022.19V	71301023.19V	71301130.19V

System width	-8		
System depth	/3	/4	/5
Dimensions W x D x H [mm]	926 x 376 x 3	926 x 488 x 3	926 x 600 x 3
Weight [kg]	0.80	1.05	1.30
Assembled/packed	Packed		
Order ref.	71301024.19V	71301025.19V	71301131.19V

System width	-9		
System depth	/3	/4	/5
Dimensions W x D x H [mm]	1038 x 376 x 3	1038 x 488 x 3	1038 x 600 x 3
Weight [kg]	0.90	1.20	1.50
Assembled/packed	Packed		
Order ref.	71301026.19V	71301027.19V	71301028.19V

System width	-9	
System depth	/7	/9
Dimensions W x D x H [mm]	1038 x 824 x 3	1038 x 1048 x 3
Weight [kg]	2.10	2.80
Assembled/packed	Packed	
Order ref.	71301138.19V	71301029.19V

System width	-10		
System depth	/3	/4	/5
Dimensions W x D x H [mm]	1150 x 376 x 3	1150 x 488 x 3	1150 x 600 x 3
Weight [kg]	1.00	1.35	1.65
Assembled/packed	Packed		
Order ref.	71301030.19V	71301031.19V	71301032.19V

Small parts storage boxes for drawers

Small parts storage boxes - pack of 10



- For the clear and orderly storage of small parts
- Complete kits for a simple, fast and customised subdivision of drawers
- Rounded corners for easy removal of small parts
- Suitable for bott vario3 drawers with front height 100 and 125 mm, cubio drawers, Systainer³ Organizers and varioCase service cases
- Boxes can be labelled with the addition of a label clip

Dimensions W x D x H [mm]	50 x 50 x 68	75 x 50 x 68	75 x 75 x 68	75 x 150 x 68
Weight [kg]	0.22	0.28	0.37	0.60
Pack of	10			
Order ref.	73510009.16	73510010.16	73510011.16	73510012.16

Dimensions W x D x H [mm]	100 x 150 x 68	150 x 150 x 68	300 x 150 x 68
Weight [kg]	0.72	0.93	1.58
Pack of	10		
Order ref.	73510013.16	73510014.16	73510015.16

Dimensions W x D x H [mm]	50 x 100 x 68	100 x 100 x 68	100 x 350 x 68
Weight [kg]	0.40	0.50	1.60
Pack of	10		
Order ref.	73510255.16	73510256.16	73510257.16

Sorting boxes

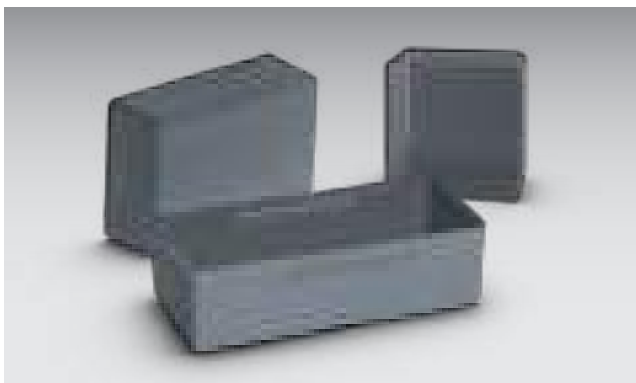

- Suitable for bott vario3 drawers with a front height of 150 mm or more
- For clear and orderly storage of small parts, consumables and tools
- Complete kits for a simple, fast and customised subdivision of drawers
- Rounded corners for easy removal of small parts

Version	Sorting box 3	Sorting box 4	Sorting box 5
Dimensions W x D x H [mm]	230 x 230 x 121	342 x 230 x 121	448 x 230 x 121
Weight [kg]	0.36	0.47	0.83
Pack of	1		
Order ref.	80833655.19V	80833656.19V	80833657.19V

Small parts storage boxes for drawers

Label clip for small parts storage boxes



- 40 Label clips made of transparent plastic
- Ideally matched to label printer with 12 mm height

Version	Labelling kit
Dimensions W x D x H [mm]	39 x 1 x 13
Weight [kg]	0.20
Pack of	40
Order ref.	72522039.90V

Dividers for drawer height 100/125 mm

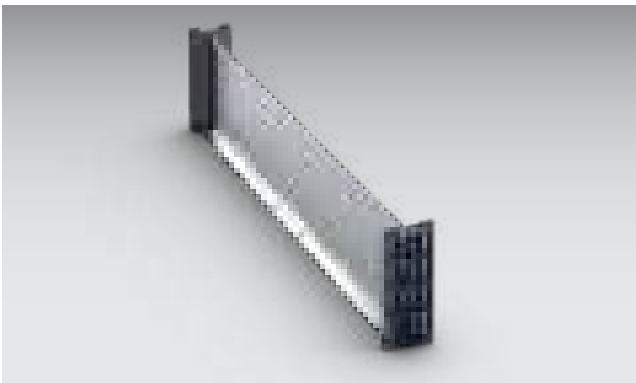

- Natural aluminium
- Height 75 mm
- Pack of 2
- Incl. 2 divider holders that snap into place
- Colour: anthracite grey (RAL 7016)

For drawers	Depth 291 mm	Depth 391 mm	Depth 491 mm
System depth	/3	/4	/5
Dimensions W x D x H [mm]	30 x 376 x 75	30 x 488 x 75	30 x 600 x 75
Usable depth [mm]	300	400	500
Weight [kg]	0.16	0.21	0.60
Pack of	2		
Assembled/packed	Packed		
Order ref.	73001024.19V	73001026.19V	73001028.19V

Dividers for drawers

Dividers for drawers from height 150 mm

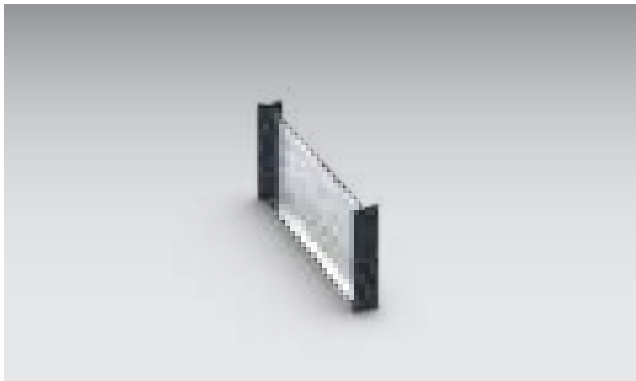

- Natural aluminium
- Height 125 mm
- Pack of 2
- Incl. 2 divider holders that snap into place
- Colour: anthracite grey (RAL 7016)

For drawers	Depth 291 mm	Depth 391 mm	Depth 491 mm
System depth	/3	/4	/5
Dimensions W x D x H [mm]	30 x 376 x 125	30 x 488 x 125	30 x 600 x 125
Usable depth [mm]	300	400	500
Weight [kg]	0.27	0.34	1.00
Pack of	2		
Assembled/packed	Packed		
Order ref.	73001025.19V	73001027.19V	73001029.19V

Dividers for drawers from height 300 mm

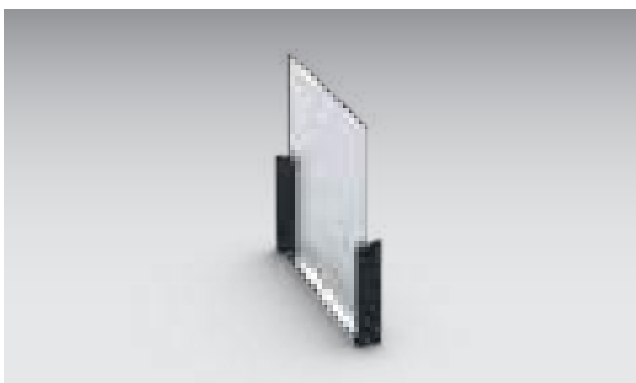

- Anodised aluminium
- Height 256 mm
- Pack of 2
- Incl. 2 divider holders that snap into place
- Colour: anthracite grey (RAL 7016)

For drawers	Depth 291 mm	Depth 391 mm	Depth 491 mm
System depth	/3	/4	/5
Dimensions W x D x H [mm]	30 x 376 x 300	30 x 488 x 300	30 x 600 x 300
Usable depth [mm]	300	400	500
Weight [kg]	1.22	1.63	2.01
Pack of	2		
Assembled/packed	Packed		
Order ref.	73001014.19V	73001015.19V	73001016.19V

Cross dividers for drawers

Dividers for drawers height 100/125 mm

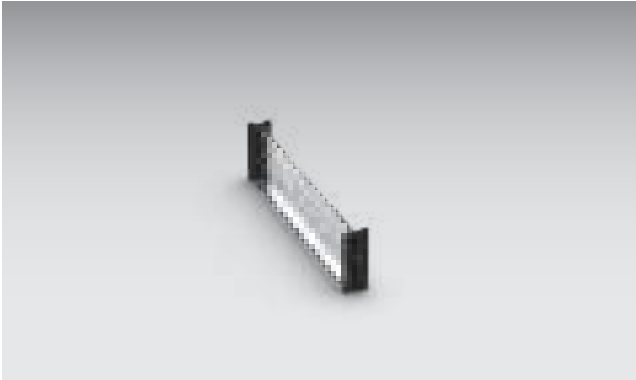

- Natural aluminium
- Height 75 mm
- Pack of 2
- Incl. 2 divider holders that snap into place
- Colour: anthracite grey (RAL 7016)

For drawers	Width 244 mm	Width 346 mm	Width 468 mm	Width 916 mm
System width	-3	-4	-5	-9
Dimensions W x D x H [mm]	366 x 30 x 75	478 x 30 x 75	590 x 30 x 75	1038 x 30 x 75
Usable width [mm]	250	350	475	925
Weight [kg]	0.14	0.18	0.58	1.08
Pack of	2			
Assembled/packed	Packed			
Order ref.	73001008.19V	73001010.19V	73001012.19V	73001017.19V

Dividers for drawers from height 150 mm

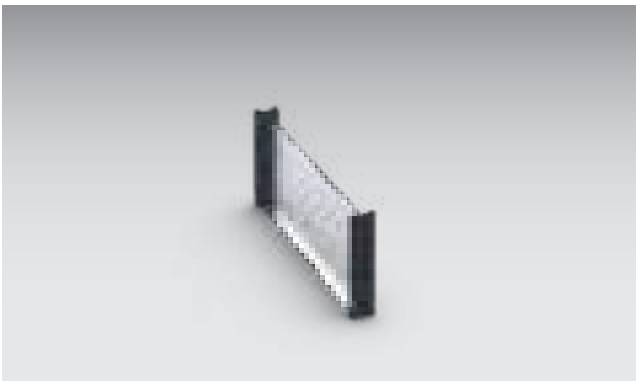

- Natural aluminium
- Height 125 mm
- Pack of 2
- Incl. 2 divider holders that snap into place
- Colour: anthracite grey (RAL 7016)

For drawers	Width 244 mm	Width 346 mm	Width 468 mm	Width 916 mm
System width	-3	-4	-5	-9
Dimensions W x D x H [mm]	366 x 30 x 125	478 x 30 x 125	590 x 30 x 125	1038 x 30 x 125
Usable width [mm]	250	350	475	925
Weight [kg]	0.23	0.32	0.96	1.77
Pack of	2			
Assembled/packed	Packed			
Order ref.	73001009.19V	73001011.19V	73001013.19V	73001018.19V

Dividers for drawers

Dividers for drawer height 100/125 mm



- Natural aluminium
- Height 68 mm
- Pack of 2
- Incl. 2 cross divider holders and 1 divider holder that snap into place
- Colour: anthracite grey (RAL 7016)

Dimensions W x D x H [mm]	92 x 1 x 68	117 x 1 x 68	142 x 1 x 68	192 x 1 x 68
Weight [kg]	0.04	0.06		0.08
Pack of	2			
Assembled/packed	Packed			
Order ref.	73002001.19V	73002002.19V	73002003.19V	73002004.19V

Dividers for drawers from height 150 mm



- Natural aluminium
- Height 118 mm
- Pack of 2
- Incl. 2 cross divider holders and 1 divider holder that snap into place
- Colour: anthracite grey (RAL 7016)

Dimensions W x D x H [mm]	92 x 1 x 118	117 x 1 x 118	142 x 1 x 118	192 x 1 x 118
Weight [kg]	0.06	0.08	0.10	0.13
Pack of	2			
Assembled/packed	Packed			
Order ref.	73002005.19V	73002006.19V	73002007.19V	73002008.19V

Cartridge insert for drawers

Cartridge insert for drawers



- Cartridge insert for drawers
- From a drawer height of 150 mm
- Width 100 mm, therefore several cartridge inserts are required to equip the entire drawer width
- Max. 5 cartridges per insert with max. Ø of 53 mm
- In drawers with the system depth / 4 and / 5, the cartridge inserts can also be inserted crosswise in the drawer to compensate for the remaining drawer depth

Dimensions W x D x H [mm]	100 x 300 x 120
Weight [kg]	0.08
Order ref.	73511012.19V

Spray can insert for drawers



- Spray can attachment for drawers
- From a drawer height of 150 mm
- Width 100 mm, therefore several cartridge inserts are required to equip the entire drawer width
- Max. 3 cartridges per insert with max. Ø of 73 mm
- In drawers with the system depth / 4 and / 5, the nozzle inserts can also be inserted transversely in the drawer to compensate for the remaining drawer depth

Dimensions W x D x H [mm]	100 x 300 x 120
Weight [kg]	0.08
Order ref.	73511011.19V

Nozzle insert for drawers

Nozzle insert for drawers



- Nozzle insert for drawers
- For drawer heights of 100 mm or 125 mm
- Max. 30 Düsen mit max. Ø von 22 mm
- In drawers with the system depth / 4 and / 5, the nozzle inserts can also be inserted transversely in the drawer to compensate for the remaining drawer depth

Dimensions W x D x H [mm]	100 x 300 x 69
Weight [kg]	0.06
Order ref.	73511019.19V



Nozzle insert for drawers



Order on the go

To stop mobility ending at the car park, your bott vario3 van racking system is designed for the quick and easy storage of portable containers of all kinds. These include a wide range of trays, cases and boxes that were developed explicitly for bott vario3 – such as the Systainer³ case system or the bottBox plastic storage bins. This saves you both time and space, and at the same time you can be sure you are making ideal use of every opening in your racking.

Our range is highly flexible and thus guarantees perfect order for all kinds of application cases. Thus the following pages present different inlays and versatile marking and labelling options alongside containers of all kinds. A wide range of accessory products allows you to transport your equipment effortlessly and store it according to your own ideas and requirements.





The best of both worlds

Why decide between removable containers and drawers if you can have both? Your van racking system can be configured in such a way that our boxes and cases fulfil both purposes. You remain flexible – no matter whether your equipment is needed directly in the vehicle or elsewhere.



bott. mastering space and time.

bottBox without viewing window



- Sturdy, durable shelf box made of polypropylene
- Easy to clean thanks to smooth inner sides
- bottBoxes of the same width are stackable
- Removable label clip for inserting a paper strip (H = 16 mm)
- Optional label clips in 3 further colours available for colour coding
- Ergonomic recessed grip at the front
- Additional grip at the back from size M3
- Strip at the back for suspension in louvred panels
- Integrated label holder (bank card format) located on the back from size M2
- Colour: anthracite grey (RAL 7016)

bottBoxes and service cases



Version	M1	M2	M3	M4
Dimensions W x D x H [mm]	130 x 100 x 65	130 x 198 x 90	130 x 298 x 165	130 x 398 x 165
Weight [kg]	0.09	0.20	0.39	0.53
Pack of	1	1	1	1
Order ref.	13022010.19	13022011.19	13022012.19	13022014.19



Version	L3	L4	L5
Dimensions W x D x H [mm]	264 x 298 x 165	264 x 398 x 165	264 x 498 x 165
Weight [kg]	0.60	0.72	0.89
Pack of	1	1	1
Order ref.	13022013.19	13022015.19	13022017.19



Version	M2X	M3X	M4X
Dimensions W x D x H [mm]	130 x 227 x 165	130 x 339 x 165	130 x 451 x 165
Weight [kg]	0.32	0.45	0.57
Pack of	1	1	1
Order ref.	13022158.19	13022159.19	13022161.19



Version	L2X	L3X	L4X
Dimensions W x D x H [mm]	264 x 227 x 165	264 x 339 x 165	264 x 451 x 165
Weight [kg]	0.54	0.66	0.83
Pack of	1	1	1
Order ref.	13022201.19	13022160.19	13022162.19



bottBox multi-packs



- Sturdy, durable shelf box made of polypropylene
- Easy to clean thanks to smooth inner sides
- bottBoxes of the same width are stackable
- Removable label clip for inserting a paper strip (H = 16 mm)
- Optional label clips in 3 further colours available for colour coding
- Ergonomic recessed grip at the front
- Additional grip at the back from size M3
- Strip at the back for suspension on louvred panels
- Integrated label holder (bank card format) located on the back from size M2
- Colour: anthracite grey (RAL 7016)

bottBoxes and service cases



Version	M1	M2	M3	M4
Dimensions W x D x H [mm]	130 x 100 x 65	130 x 198 x 90	130 x 298 x 165	130 x 398 x 165
Weight [kg]	4.03	7.16	9.65	6.36
Pack of	48	36	24	12
Order ref.	13022045.19	13022046.19	13022047.19	13022049.19



Version	L3	L4	L5
Dimensions W x D x H [mm]	264 x 298 x 165	264 x 398 x 165	264 x 498 x 165
Weight [kg]	7.19	4.32	5.36
Pack of	12	6	6
Order ref.	13022048.19	13022050.19	13022052.19



Version	M2X	M3X	M4X
Dimensions W x D x H [mm]	130 x 227 x 165	130 x 339 x 165	130 x 451 x 165
Weight [kg]	7.68	5.40	6.84
Pack of	24	12	12
Order ref.	13022163.19	13022164.19	13022166.19



Version	L3X	L4X
Dimensions W x D x H [mm]	264 x 339 x 165	264 x 451 x 165
Weight [kg]	3.96	4.98
Pack of	6	6
Order ref.	13022165.19	13022167.19



bottBox without viewing window ESD

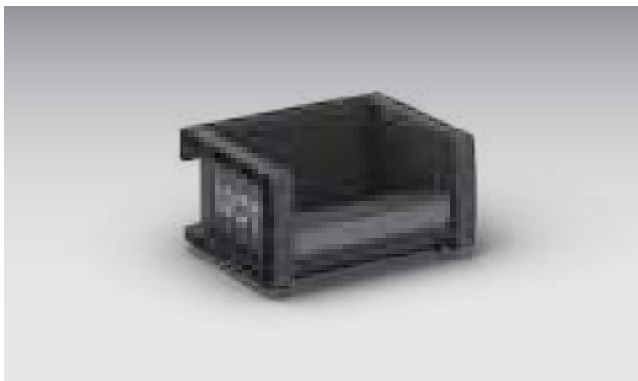

- Sturdy, durable shelf box made of polypropylene
- Easy to clean thanks to smooth inner sides
- bottBoxes of the same width are stackable
- Removable label clip for inserting a paper strip (H = 16 mm)
- Optional label clips in 3 further colours available for colour coding
- Ergonomic recessed grip at the front
- Additional grip at the back from size M3
- Strip at the back for suspension in louvred panels
- Integrated label holder (bank card format) located on the back from size M2
- Colour: ESD version black



Version	M1	M2	M3
Dimensions W x D x H [mm]	130 x 100 x 65	130 x 198 x 90	130 x 298 x 165
Weight [kg]	0.09	0.22	0.45
Pack of	1	1	1
Order ref.	13022010.72	13022011.72	13022012.72



Version	M1	M2	M3
Dimensions W x D x H [mm]	130 x 100 x 65	130 x 198 x 90	130 x 298 x 165
Weight [kg]	4.51	8.06	10.85
Pack of	48	36	24
Order ref.	13022045.72	13022046.72	13022047.72

bottBox with viewing window



- Sturdy, durable plastic bin made of polypropylene
- Incl. transparent viewing window, thus turning the grab box into a storage box with the maximum amount of usable storage volume
- The viewing window may also be used to create a hopper, making ergonomic access in the front area of the box and maximum usable volume at the rear of the bottBox possible
- Easy to clean thanks to smooth inner sides
- bottBoxes of the same width are stackable
- Removable label clip for inserting a paper strip (H = 16 mm)
- Optional label clips in 3 further colours available for colour coding
- Ergonomic recessed grip at the front
- Additional gripping option at the back from size M3
- Strip at the back for suspension in louvred panels
- Possibility of inserting a stock card in bank card format on the back from size M2
- Colour: anthracite grey (RAL 7016)



Version	M1	M2	M3	M4
Dimensions W x D x H [mm]	130 x 100 x 65	130 x 198 x 90	130 x 298 x 165	130 x 398 x 165
Weight [kg]	0.09	0.21	0.42	0.60
Pack of	1	1	1	1
Order ref.	13022037.19	13022038.19	13022039.19	13022041.19



Version	L3	L5
Dimensions W x D x H [mm]	264 x 298 x 165	264 x 498 x 165
Weight [kg]	0.67	0.96
Pack of	1	1
Order ref.	13022040.19	13022044.19

bottBox



Version	M2X	M3X	M4X
Dimensions W x D x H [mm]	130 x 227 x 165	130 x 339 x 165	130 x 451 x 165
Weight [kg]	0.34	0.47	0.60
Pack of	1	1	1
Order ref.	13022168.19	13022169.19	13022171.19



Version	L2X	L3X	L4X
Dimensions W x D x H [mm]	264 x 227 x 165	264 x 339 x 165	264 x 451 x 165
Weight [kg]	0.47	0.71	0.88
Pack of	1	1	1
Order ref.	13022202.19	13022170.19	13022172.19



bottBox with window (multi-packs)



- Sturdy, durable plastic bin made of polypropylene
- Incl. transparent viewing window, thus turning the grab box into a storage box with the maximum amount of usable storage volume
- The viewing window may also be used to create a hopper, making ergonomic access in the front area of the box and maximum usable volume at the rear of the bottBox possible
- Easy to clean thanks to smooth inner sides
- bottBoxes of the same width are stackable
- Removable label clip for inserting a paper strip (H = 16 mm)
- Optional label clips in 3 further colours available for colour coding
- Ergonomic recessed grip at the front
- Additional gripping option at the back from size M3
- Strip at the back for suspension in louvred panels
- Possibility of inserting a stock card in bank card format on the back from size M2
- Colour: anthracite grey (RAL 7016)



Version	M3X	L3X	L4X
Dimensions W x D x H [mm]	130 x 227 x 165	130 x 339 x 165	130 x 451 x 165
Weight [kg]	8.16	5.64	7.20
Pack of	24	12	12
Order ref.	13022173.19	13022174.19	13022176.19



Version	M4X	L4X
Dimensions W x D x H [mm]	264 x 339 x 165	264 x 451 x 165
Weight [kg]	4.26	5.28
Pack of	6	6
Order ref.	13022175.19	13022177.19

bottBox cross dividers



- For dividing the bottBoxes crossways from size M2
- Transparent polycarbonate (PC) makes it easier to see the contents of the rear part of the box
- Colour: transparent
- Pack of 6

For use with bottBox	M2	M2X, M3, M3X, M4, M4X	L3, L3X, L4, L4X, L5
Dimensions W x D x H [mm]	118 x 6 x 68	118 x 6 x 143	252 x 6 x 143
Weight [kg]	0.07	0.28	0.70
Pack of	6	6	6
Order ref.	13022031	13022032	13022033

bottBox viewing window

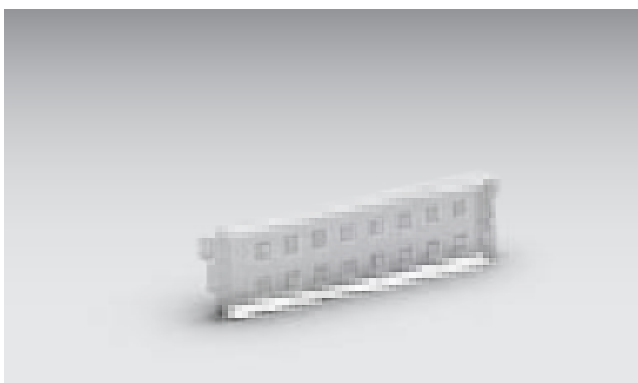

- For insertion on the front of the bottBox
- Turns the shelf box into a full-grade storage box with maximum usable storage volume
- Transparent polycarbonate (PC) makes it easier to see the contents of the box
- From size M2, the viewing window may also be used as a dispensing panel, thereby creating ergonomic access in the front area whilst retaining the maximum usable volume in the rear area
- Colour: transparent
- Pack of 6

For use with bottBox	M1, M2	M2X, M3, M3X, M4, M4X	L2X, L3, L3X, L4, L4X, L5
Dimensions W x D x H [mm]	118 x 12 x 27	118 x 12 x 88	252 x 12 x 88
Weight [kg]	0.06	0.19	0.40
Pack of	6	6	6
Order ref.	13022028	13022029	13022030

bottBox hinged lid

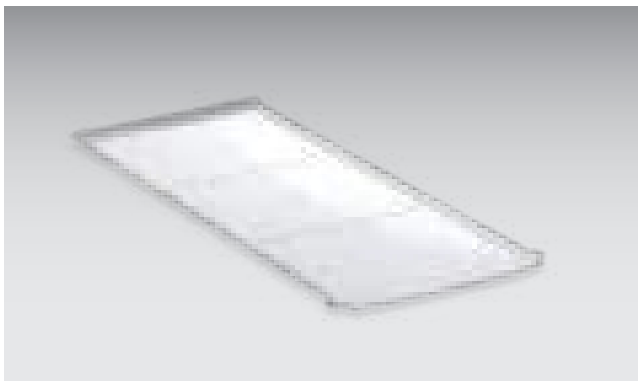

- For closing up bottBoxes
- Material: PC (Polycarbonate) / Colour: transparent

For use with bottBox	M3	M2
Dimensions W x D x H [mm]	117 x 276 x 4	117 x 192 x 4
Weight [kg]	0.54	0.36
Pack of	6	6
Order ref.	13022185	13022184

For use with bottBox	L3	L4	L5
Dimensions W x D x H [mm]	253 x 274 x 4	253 x 374 x 4	253 x 474 x 4
Weight [kg]	1.27	1.70	2.12
Pack of	6	6	6
Order ref.	13022034	13022035	13022036

bottBox labelling kit



- Document templates for sheets of labels are available free of charge at www.bott.de/service/downloads

Weight [kg]	0.06	0.10
Order ref.	61020003	43020001

bottBox label clip

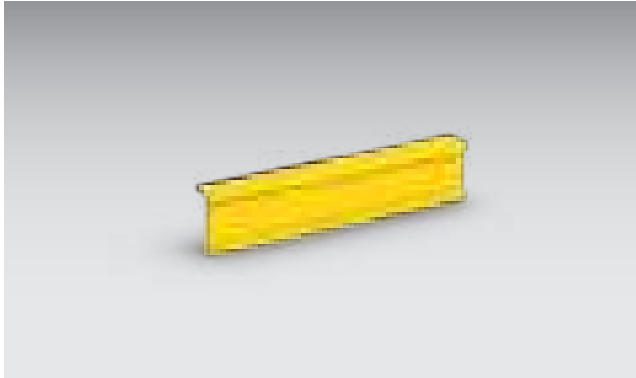

- For colour coding the bottBoxes
- With groove for insertion of a paper strip (H = 16 mm)
- For clipping onto the bottBox body



For use with bottBox	M1, M2, M2X, M3, M3X, M4, M4X	M1, M2, M2X, M3, M3X, M4, M4X	M1, M2, M2X, M3, M3X, M4, M4X
Colour RAL	RAL 1023	RAL 5010	RAL 3001
Colour	Traffic yellow	Gentian blue	Signal red
Dimensions W x D x H [mm]	103 x 11 x 20	103 x 11 x 20	103 x 11 x 20
Weight [kg]	0.14	0.14	0.14
Pack of	36	36	36
Order ref.	13022024.12	13022024.11	13022024.04



bottBox label clip

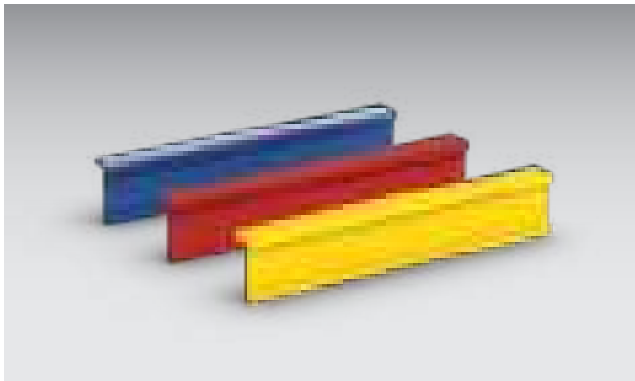

- For colour coding the bottBoxes
- With groove for insertion of a paper strip (H = 16 mm)
- For clipping onto the bottBox body



For use with bottBox	M1, M2, M2X, M3, M3X, M4, M4X	L3, L3X, L4, L4X, L5
Colour RAL	1023/5010/3001	1023/5010/3001
Dimensions W x D x H [mm]	103 x 11 x 20	237 x 11 x 20
Weight [kg]	0.14	0.36
Pack of	36	36
Order ref.	13022025	13022027



Systainer³ M case systems

Systainer³ M empty case for custom configuration



- Practical and sturdy system case for the secure storage and transport of power tools, hand tools, small parts and consumables
- Simple integration in bott vario3 in-vehicle equipment and bott workshop equipment via moulded guide rail slots
- Multifunctional T-LOC: close, open, connect - with just one twist
- 2 integrated label holders on the front of the case (bank card format)
- Can be stacked and linked to all other systainer products
- Load bearing capacity (single): 20 kg
- Load bearing capacity (when connected): 40 kg
- Material: ABS



Description	Systainer ³ M 112	Systainer ³ M 137	Systainer ³ M 187
Assembly	Empty	Empty	Empty
Dimensions W x D x H [mm]	396 x 296 x 112	396 x 296 x 137	396 x 296 x 187
Weight [kg]	1.46	1.56	1.72
Order ref.	72520003.19V	72520004.19V	72520005.19V



Description	Systainer ³ M 237	Systainer ³ M 337	Systainer ³ M 437
Assembly	Empty	Empty	Empty
Dimensions W x D x H [mm]	396 x 296 x 237	396 x 296 x 337	396 x 296 x 437
Weight [kg]	1.96	2.46	2.98
Order ref.	72520006.19V	72520007.19V	72520008.19V

Systainer³ M case systems

Systainer³ M 187 with boxes



- Practical and sturdy system case for the secure storage and transport of small parts and consumables
- Equipped with 2 removable box trays with small parts storage boxes
- incl. EPP lid insert
- Simple integration in bott vario3 in-vehicle equipment and bott workshop equipment thanks to moulded guide rail slots
- Multifunctional T-LOC: close, open, connect - with just one twist
- 2 integrated label holders on the front of the case (bank card format)
- Can be stacked and linked to all other systainer products
- Load bearing capacity (single): 20 kg
- Load bearing capacity (when connected): 40 kg
- Case material: ABS
- Box tray material: powder-coated aluminium



Description	Systainer ³ M 187	Systainer ³ M 187	Systainer ³ M 187
Assembly	18 boxes	25 boxes	32 boxes
Dimensions W x D x H [mm]	396 x 296 x 187	396 x 296 x 187	396 x 296 x 187
Weight [kg]	3.58	3.66	3.78
Order ref.	72520050.19V	72520058.19V	72520059.19V

Systainer³ M case systems

Systainer³ M 112 with universal inlay



- Practical and sturdy system case for the secure storage and transport of small parts and consumables
- Equipped with universal inlay with 10 differently sized compartments and lid insert
- Simple integration in bott vario3 in-vehicle equipment and bott workshop equipment via moulded guide rail slots
- Multifunctional T-LOC: close, open, connect - with just one twist
- 2 integrated label holders on the front of the case (bank card format)
- Can be stacked and linked to all other systainer products
- Load bearing capacity (single): 20 kg
- Load bearing capacity (when connected): 40 kg
- Material: ABS

Description	Systainer ³ M 112
Assembly	Universal inlay with 10 compartments
Dimensions W x D x H [mm]	396 x 296 x 112
Weight [kg]	1.70
Order ref.	72520027.19V

Systainer³ M112 First Aid Kit



- Packed in accordance with DIN 13157 incl. divider kit and lid insert
- Body: anthracite grey RAL 7016, lid: anthracite grey RAL 7016 with green lid handle and logo printed in silver, T-LOC: anthracite grey RAL 7016 with green details
- Load capacity 20 kg

Dimensions W x D x H [mm]	396 x 296 x 112
Weight [kg]	2.27
Order ref.	72520090.19V

First-aid refill pack in accordance with DIN 13157

Dimensions W x D x H [mm]	210 x 210 x 115
Weight [kg]	0.70
Order ref.	73508080

Systainer³ M case systems

Systainer³ M with compartment divider set



- Practical and sturdy system case for the secure storage and transport of hand tools, small parts and consumables
- Equipped with compartment divider set for the division of the case into up to 6 equally sized compartments
- Simple integration in bott vario3 in-vehicle equipment and bott workshop equipment thanks to moulded guide rail slots
- Multifunctional T-LOC: close, open, connect - with just one twist
- 2 integrated label holders on the front of the case (bank card format)
- Can be stacked and linked to all other systainer products
- Load bearing capacity (single): 20 kg
- Load bearing capacity (when connected): 40 kg
- Material: ABS



Description	Systainer ³ M 112	Systainer ³ M 137	Systainer ³ M 187
Assembly	Compartment divider set Lid insert	Compartment divider set Lid insert	Compartment divider set Lid insert
Dimensions W x D x H [mm]	396 x 296 x 112	396 x 296 x 137	396 x 296 x 187
Weight [kg]	1.40	1.55	1.65
Order ref.	72520052.19V	72520053.19V	72520054.19V



Description	Systainer ³ M 237	Systainer ³ M 337	Systainer ³ M 437
Assembly	Compartment divider set	Compartment divider set	Compartment divider set
Dimensions W x D x H [mm]	396 x 296 x 237	396 x 296 x 337	396 x 296 x 437
Weight [kg]	2.00	2.30	2.90
Order ref.	72520047.19V	72520048.19V	72520049.19V

Systainer³ M case systems

Systainer³ M with die-cut foam insert



- Practical and sturdy system case for the secure storage and transport of hand tools, small parts and consumables
- Equipped with foam cushion, die-cut foam inserts (25mm pitch) and lid pad for designing individual inserts
- Simple integration in bott vario3 in-vehicle equipment and bott workshop equipment via moulded guide rail slots
- Multifunctional T-LOC: close, open, connect - with just one twist
- 2 integrated label holders on the front of the case (bank card format)
- Can be stacked and linked to all other systainer products
- Load bearing capacity (single): 20 kg
- Load bearing capacity (when connected): 40 kg
- Material: ABS



Description	Systainer ³ M 112	Systainer ³ M 137	Systainer ³ M 187
Assembly	1x foam cushion 1x die-cut foam insert 1x lid pad	1x foam cushion 1x die-cut foam insert 1x lid pad	1x foam cushion 3x die-cut foam insert 1x lid pad
Dimensions W x D x H [mm]	396 x 296 x 112	396 x 296 x 137	396 x 296 x 187
Weight [kg]	1.50	1.60	1.70
Order ref.	72520038.19V	72520039.19V	72520040.19V



Description	Systainer ³ M 237	Systainer ³ M 337	Systainer ³ M 437
Assembly	1x foam cushion 5x die-cut foam insert 1x lid pad	1x foam cushion 5x die-cut foam insert 1x lid pad	1x foam cushion 5x die-cut foam insert 1x lid pad
Dimensions W x D x H [mm]	396 x 296 x 237	396 x 296 x 337	396 x 296 x 437
Weight [kg]	2.00	2.30	2.90
Order ref.	72520041.19V	72520042.19V	72520043.19V

Systainer³ M case systems

Systainer³ M with spray can insert



- Practical and sturdy system case for the secure storage and transport of spray cans
- Equipped with spray can insert made of EPP for 14 cans with max. diameter 69 mm
- Simple integration in bott vario3 in-vehicle equipment and bott workshop equipment via moulded guide rail slots
- Multifunctional T-LOC: close, open, connect - with just one twist
- 2 integrated label holders on the front of the case (bank card format)
- Can be stacked and linked to all other systainer products
- Load bearing capacity (single): 20 kg
- Load bearing capacity (when connected): 40 kg
- Material: ABS



Description	Systainer ³ M 337	Systainer ³ M 437
Assembly	Spray can insert	Spray can insert
Dimensions W x D x H [mm]	396 x 296 x 337	396 x 296 x 437
Weight [kg]	2.71	3.23
Order ref.	72520029.19V	72520030.19V

Systainer³ M case systems

Systainer³ M with cartridge storage insert



- Practical and sturdy system case for the secure storage and transport of cartridges
- Equipped with cartridge storage insert made of EPP for 22 cartridges with max. diameter 51 mm and 15 cartridge nozzles
- Simple integration in bott vario3 in-vehicle equipment and bott workshop equipment via moulded guide rail slots
- Multifunctional T-LOC: close, open, connect - with just one twist
- 2 integrated label holders on the front of the case (bank card format)
- Can be stacked and linked to all other systainer products
- Load bearing capacity (single): 20 kg
- Load bearing capacity (when connected): 40 kg
- Material: ABS



Description	Systainer ³ M 337	Systainer ³ M 437
Assembly	Cartridge storage insert	Cartridge storage insert
Dimensions W x D x H [mm]	396 x 296 x 337	396 x 296 x 437
Weight [kg]	2.35	2.95
Order ref.	72520031.19V	72520032.19V

Systainer³ M case systems

Systainer³ M with insulating insert



- Practical and sturdy system case for the secure storage and transport of temperature-sensitive contents
- Equipped with insulating EPP moulded parts in the lid and body
- Maintains the temperature for up to 24 hours
- Simple integration in bott vario3 van racking and bott workshop equipment thanks to moulded guide rail slots
- Multifunctional T-LOC : close, open, connect with just one twist
- Marking possibility thanks to 2 integrated label holders on the front of the case (bank card format)
- Can be stacked and linked to all other systainer products
- Load bearing capacity (single): 20 kg
- Load bearing capacity (when connected): 40 kg
- Material: ABS



Description	Systainer ³ M 237	Systainer ³ M 337	Systainer ³ M 437
Assembly	Insulating insert	Insulating insert	Insulating insert
Dimensions W x D x H [mm]	396 x 296 x 237	396 x 296 x 337	396 x 296 x 437
Weight [kg]	2.28	3.10	3.54
Order ref.	72520086.19V	72520085.19V	72520087.19V

Systainer³ L case systems

Systainer³ L empty case for custom configuration



- Practical and sturdy system case for the secure storage and transport of power tools, hand tools, small parts and consumables
- Simple integration in bott vario3 in-vehicle equipment and bott workshop equipment via moulded guide rail slots
- Multifunctional T-LOC: close, open, connect - with just one twist
- 2 integrated label holders on the front of the case (bank card format)
- Can be stacked and linked to all other systainer products
- Load bearing capacity (single): 20 kg
- Load bearing capacity (when connected): 40 kg
- Material: ABS



Description	Systainer ³ L 137	Systainer ³ L 187	Systainer ³ L 237
Assembly	Empty	Empty	Empty
Dimensions W x D x H [mm]	508 x 296 x 137	508 x 296 x 187	508 x 296 x 237
Weight [kg]	2.06	2.26	2.54
Order ref.	72520009.19V	72520010.19V	72520011.19V



Systainer³ L case systems

Systainer³ L 187 with boxes



- Practical and sturdy system case for the secure storage and transport of small parts and consumables
- Equipped with 2 removable box trays with small parts storage boxes
- incl. EPP lid insert
- Simple integration in bott vario3 in-vehicle equipment and bott workshop equipment thanks to moulded guide rail slots
- Multifunctional T-LOC: close, open, connect - with just one twist
- 2 integrated label holders on the front of the case (bank card format)
- Can be stacked and linked to many other systainer products
- Load bearing capacity (single): 20 kg
- Load bearing capacity (when connected): 40 kg
- Case material: ABS
- Box tray material: powder-coated aluminium



Description	Systainer ³ L 187	Systainer ³ L 187	Systainer ³ L 187
Assembly	20 boxes	29 boxes	38 boxes
Dimensions W x D x H [mm]	508 x 296 x 187	508 x 296 x 187	508 x 296 x 187
Weight [kg]	4.58	4.70	4.84
Order ref.	72520051.19V	72520060.19V	72520061.19V

Systainer³ L case systems

Systainer³ L 137 with universal inlay



- Practical and sturdy system case for the secure storage and transport of small parts and consumables
- Equipped with universal insert with 6 differently sized compartments and lid insert
- Simple integration in bott vario3 in-vehicle equipment and bott workshop equipment via moulded guide rail slots
- Multifunctional T-LOC: close, open, connect - with just one twist
- 2 integrated label holders on the front of the case (bank card format)
- Can be stacked and linked to many other systainer products
- Load bearing capacity (single): 20 kg
- Load bearing capacity (when connected): 40 kg
- Material: ABS

Description	Systainer ³ L 137
Assembly	Universal insert with 6 compartments
Dimensions W x D x H [mm]	508 x 296 x 137
Weight [kg]	2.00
Order ref.	72520028.19V



Systainer³ L case systems

Systainer³ L 187 with compartment divider set



- Practical and sturdy system case for the secure storage and transport of hand tools, small parts and consumables
- Equipped with compartment divider set for the division of the case into up to 6 equally sized compartments
- Simple integration in bott vario3 in-vehicle equipment and bott workshop equipment thanks to nmoulded guide rail slots
- Multifunctional T-LOC: close, open, connect - with just one twist
- 2 integrated label holders on the front of the case (bank card format)
- Can be stacked and linked to many other systainer products
- Load bearing capacity (single): 20 kg
- Load bearing capacity (when connected): 40 kg
- Material: ABS



Description	Systainer ³ L 137	Systainer ³ L 187	Systainer ³ L 237
Assembly	Compartment divider set Lid insert	Compartment divider set Lid insert	Compartment divider set
Dimensions W x D x H [mm]	508 x 296 x 137	508 x 296 x 187	508 x 296 x 237
Weight [kg]	1.75	2.00	2.20
Order ref.	72520055.19V	72520056.19V	72520057.19V

Systainer³ L case systems

Systainer³ L with die-cut foam insert



- Practical and sturdy system case for the secure storage and transport of hand tools, small parts and consumables
- Equipped with foam cushion, die-cut foam inserts (25mm pitch) and lid pad for designing individual inserts
- Simple integration in bott vario3 in-vehicle equipment and bott workshop equipment via moulded guide rail slots
- Multifunctional T-LOC: close, open, connect - with just one twist
- 2 integrated label holders on the front of the case (bank card format)
- Can be stacked and linked to many other systainer products
- Load bearing capacity (single): 20 kg
- Load bearing capacity (when connected): 40 kg
- Material: ABS



Description	Systainer ³ L 137	Systainer ³ L 187	Systainer ³ L 237
Assembly	1x foam cushion 1x die-cut foam insert 1x lid pad	1x foam cushion 3x die-cut foam insert 1x lid pad	1x foam cushion 5x die-cut foam insert 1x lid pad
Dimensions W x D x H [mm]	508 x 296 x 137	508 x 296 x 187	508 x 296 x 237
Weight [kg]	1.85	2.05	3.24
Order ref.	72520044.19V	72520045.19V	72520046.19V

Systainer³ L case systems

Systainer³ L with tool insert



- Practical and sturdy system case for the secure storage and transport of hand tools
- Equipped with tool insert and lid insert / lid bag
- The tool required can be found quickly thanks to the clear storage of the hand tools required
- Simple integration in bott vario3 in-vehicle equipment and bott workshop equipment thanks to moulded guide rail slots
- Multifunctional T-LOC: close, open, connect - with just one twist
- Marking possibility thanks to 2 integrated label holders on the front of the case (bank card format)
- Can be stacked and linked to many other systainer products
- Load bearing capacity (single): 20 kg
- Load bearing capacity (when connected): 40 kg
- Material: ABS



Description	Systainer ³ L 187	Systainer ³ L 237
Assembly	Tool insert and lid bag	Tool insert and lid bag
Dimensions W x D x H [mm]	508 x 296 x 187	508 x 296 x 237
Weight [kg]	2.40	2.60
Order ref.	72520034.19V	72520035.19V

Systainer³ XXL case systems

Systainer³ XXL empty case for custom configuration



- Practical and sturdy system case for the secure storage and transport of machines, hand tools, small parts and consumables
- Multifunctional T-LOC: close, open, connect with just one twist
- Marking possibility thanks to 2 integrated label holders on the front of the case (bank card format)
- Can be stacked and linked to all other systainer products
- Load bearing capacity (single): 20 kg
- Load bearing capacity (when connected): 40 kg
- Material: ABS



Description	Systainer ³ XXL 237	Systainer ³ XXL 337
Assembly	Empty	Empty
Dimensions W x D x H [mm]	792 x 296 x 237	792 x 296 x 337
Weight [kg]	3.64	4.33
Order ref.	72520088.19V	72520089.19V

bott Systainer³ XXL case floor lashing insert



- Simple and flexible securing of objects in bott Systainer³ XXL
- Base shelf infill for bott Systainer³ XXL with two cam-buckle-straps
- Material: PP / grey

Dimensions W x D x H [mm]	750 x 269 x 4
Weight [kg]	0.50
Order ref.	72520094.16V

Accessories for Systainer³ case systems

Labelling kit



- For the clean and orderly labelling of the cases
- Reduces search times and increases efficiency
- Suitable for all systainer³ M and L
- For use in the integrated label holders on the front of the case
- Comprising 20 transparent cards and 2 labelling sheets with 10 paper cards each for tearing off

Description	Labelling kit
Dimensions W x D x H [mm]	86 x 1 x 54
Weight [kg]	0.09
Order ref.	72522038

Transport trolley with drawer



- Practical dolly for the convenient transport of systainer system cases
- Simple movement over steps thanks to large wheels
- Integrated drawer for stowing small parts (load capacity 5 kg)
- With variably adjustable safety belt
- Dolly and hand truck function
- Suitable for all cases with basic dimensions 400 x 300 mm
- Wheel diameter front: 75 mm
- Wheel diameter rear: 200 mm
- Load capacity 100 kg

Description	Transport trolley with drawer
Dimensions W x D x H [mm]	600 x 440 x 1100
Weight [kg]	6.50
Order ref.	72522030.90V

Accessories for Systainer³ case systems

Systainer³ dolly

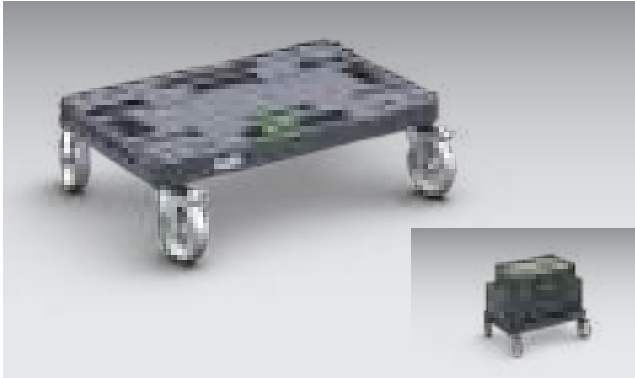

- For the fast and straightforward transport of several cases
- Suitable for all systainer³ M and L
- Optimum running and stability thanks to large wheels and wheel spacing
- Simple integration in bott vario3 in-vehicle equipment via moulded guide rail slots (width 5 / flat height 175mm)
- 4 swivel castors, front with 2x brake castors
- Wheel diameter: 100 mm
- Load capacity 100 kg
- Colour: anthracite grey

Description	Systainer ³ dolly
Dimensions W x D x H [mm]	508 x 397 x 160
Weight [kg]	2.96
Order ref.	72522029.19V

Bracket for Systainer³ dolly



- For the fast, simple and safe storage of the Systainer³ dolly
- Noise reduced by rubber buffers
- For installation at the side on the bott vario3 SLF frames or perforated panels
- Material: powder-coated aluminium (RAL 7016)

Version	Holder for Systainer ³ dolly
Dimensions W x D x H [mm]	290 x 66 x 439
Weight [kg]	0.68
Order ref.	73508025.19V

Accessories for Systainer³ case systems

Guide rail storage brackets for portable circular saws



- Used to install guide rails for hand-held circular saws
- Can be attached to the SLF T-nut, to lashing rails or to perfo panels
- With holder bracket on the left and right side, each fitted with adhesive tape
- For Festool, Bosch and Makita guide rails
- Painted steel RAL 7016

Dimensions W x D x H [mm]	85 x 36 x 189
Weight [kg]	0.70
Order ref.	73508079.19V



Accessories for Systainer³ case systems

Inserts for Systainer³ M



Designation	Universal inlay	Floor cushion	Cross floor cushion
Description	With 10 compartments of different sizes For the orderly storage and safe transport of small parts and consumables Height of the compartments: 65 mm Base area of the compartments: 107 x 72 mm (3x) 109 x 110 mm (3x) 52 x 54 mm (4x) Material: PS Colour: black	For optimum protection of the contents Cushions and protects objects that are transported in the case Material: PUR soft foam Colour: anthracite grey	Creates a level and continuous surface in the systainer ³ M Material: PE hard foam Colour: anthracite grey
Dimensions W x D x H [mm]	382 x 282 x 74	373 x 274 x 25	376 x 275 x 10
Weight [kg]	0.20	0.05	0.02
Order ref.	72522024	72522009	72522010



Designation	Lid cushion	Lid insert	Lid bag for office supplies	Die-cut foam insert
Description	For optimum protection of the contents Cushions and protects objects that are transported in the case Mounting on the lid is by means of a small adhesive strip on the back Material: PUR soft foam Colour: anthracite grey	For the clear storage of various office materials such as pens, calling cards, writing pads and other utensils.incl. 4 screws for mounting on the lid	For the clear storage of various office materials such as pens, calling cards, writing pads and other utensils.incl. 4 screws for mounting on the lid	Die-cut foam insert with pre-cut cube pattern (15 x 15 mm) for customised adaptation to the contents Makes tailor-made protection possible for sensitive contents Material: PE hard foam Colour: anthracite grey
Dimensions W x D x H [mm]	365 x 225 x 25	-	378 x 245 x 20	373 x 274 x 25
Weight [kg]	0.06	0.06	0.19	0.07
Order ref.	72522011	72522027	72522023	72522012



Designation	Case trays with 18 boxes	Case trays with 25 boxes	Case trays with 32 boxes
Dimensions W x D x H [mm]	388 x 283 x 138	388 x 283 x 138	388 x 283 x 138
Weight [kg]	1.78	1.88	1.98
Order ref.	73510261.19V	73510262.19V	73510263.19V

Accessories for Systainer³ case systems

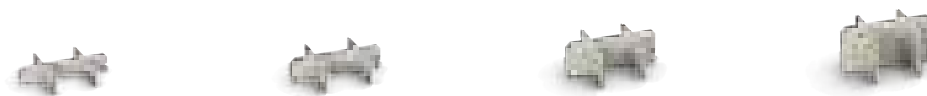

Designation	Compartment divider set	Compartment divider set	Compartment divider set	Compartment divider set
Description	For division of the case in 6 approximately equally sized compartments For clear organisation of tools and larger consumables Set comprising one longitudinal divider and 2 cross dividers An EPP lid insert is recommended in addition for systainers with a front carry handle Material: PP twin-wall sheet Colour: light grey	For division of the case in 6 approximately equally sized compartments For clear organisation of tools and larger consumables Set comprising one longitudinal divider and 2 cross dividers An EPP lid insert is recommended in addition for systainers with a front carry handle Material: PP twin-wall sheet Colour: light grey	For division of the case in 6 approximately equally sized compartments For clear organisation of tools and larger consumables Set comprising one longitudinal divider and 2 cross dividers An EPP lid insert is recommended in addition for systainers with a front carry handle Material: PP twin-wall sheet Colour: light grey	For division of the case in 6 approximately equally sized compartments For clear organisation of tools and larger consumables Set comprising one longitudinal divider and 2 cross dividers An EPP lid insert is recommended in addition for systainers with a front carry handle Material: PP twin-wall sheet Colour: light grey
Dimensions W x D x H [mm]	-	-	-	-
Weight [kg]	0.10	0.14	0.20	0.29
Order ref.	72522031.95	72522032.95	72522033.95	72522034.95



Designation	Spray can insert	Cartridge storage insert
For case type	Systainer ³ M 337 / M 437	Systainer ³ M 337 / M 437
Description	For the safe and straightforward transport of spray cans For 14 cans with max. diameter 69 mm Incl. cut-out for holding spray cans with spray tube Material: EPP moulded foam Colour: black	For the safe and straightforward transport of cartridges For 22 cartridges with max. diameter 51 mm Incl. 15 cut-outs for holding cartridge tips Material: EPP moulded foam Colour: black
Dimensions W x D x H [mm]	386 x 283 x 140	385 x 283 x 125
Weight [kg]	0.25	0.25
Order ref.	72522021	72522020

Accessories for Systainer³ case systems

Inserts for Systainer³ L



Designation	Universal inlay	Floor cushion	Cross floor cushion
Description	With 6 compartments of different sizes For the orderly storage and safe transport of small parts and consumables Height of the compartments: 85 mm Base area of the compartments: 351 x 96 mm, 149 x 96 mm, 99 x 96 mm (2x), 77 x 96 mm, 51 x 96 mm Material: PS Colour: black	For optimum protection of the contents Cushions and protects objects that are transported in the case Material: PUR soft foam Colour: anthracite grey	Creates a level and continuous surface in the systainer ³ L Material: PE hard foam Colour: anthracite grey
Dimensions W x D x H [mm]	498 x 288 x 88	484 x 287 x 25	482 x 289 x 10
Weight [kg]	0.40	0.06	0.03
Order ref.	72522018	72522013	72522014



Designation	Lid cushion	Die-cut foam insert	Tool holding insert
Description	For optimum protection of the contents Cushions and protects objects that are transported in the case Mounting on the lid is by means of a small adhesive strip on the back Material: PUR soft foam Colour: anthracite grey	Die-cut foam insert with pre-cut cube pattern (15 x 15 mm) for customised adaptation to the contents Makes tailor-made protection possible for sensitive contents Material: PE hard foam Colour: anthracite grey	Tool insert with tool lid for the safe, clear and tidy storage of hand tools Tool insert with dividers and cross dividers for flexible subdivision Suitable for different hand tools such as pliers, screwdrivers etc. Tool insert material: EPP Tool lid material: polyethylene / polyester
Dimensions W x D x H [mm]	465 x 225 x 25	484 x 287 x 25	-
Weight [kg]	0.08	0.09	0.40
Order ref.	72522015	72522016	72522019

Accessories for Systainer³ case systems



Designation	Lid bag	Lid insert
Description	For the clear storage of hand tools Incl. 6 screws for installation on the lid	For the clear storage of various office materials such as pens, calling cards, writing pads and other utensils Incl. 4 screws for mounting on the lid
Dimensions W x D x H [mm]	478 x 228 x 40	-
Weight [kg]	0.20	0.06
Order ref.	72522017	72522028



Designation	Case trays with 20 boxes	Case trays with 29 boxes	Case trays with 38 boxes
Dimensions W x D x H [mm]	500 x 283 x 138	500 x 283 x 138	500 x 283 x 138
Weight [kg]	2.20	2.34	2.48
Order ref.	73510264.19V	73510265.19V	73510266.19V



Designation	Compartment divider set	Compartment divider set	Compartment divider set
Description	For division of the case in 6 approximately equally sized compartments For clear organisation of tools and larger consumables Set comprising one longitudinal divider and 2 cross dividers An EPP lid insert is recommended in addition for systainers with a front carry handle Material: PP twin-wall sheet Colour: light grey	For division of the case in 6 approximately equally sized compartments For clear organisation of tools and larger consumables Set comprising one longitudinal divider and 2 cross dividers An EPP lid insert is recommended in addition for systainers with a front carry handle Material: PP twin-wall sheet Colour: light grey	For division of the case in 6 approximately equally sized compartments For clear organisation of tools and larger consumables Set comprising one longitudinal divider and 2 cross dividers An EPP lid insert is recommended in addition for systainers with a front carry handle Material: PP twin-wall sheet Colour: light grey
Dimensions W x D x H [mm]	-	-	-
Weight [kg]	0.16	0.22	0.31
Order ref.	72522035.95	72522036.95	72522037.95

Systainer³ organizer M + L case systems

Systainer³ organizer empty case for custom configuration



- Practical and sturdy system case for the secure storage and transport of small parts and consumables
- Transparent lid allows you to see the contents and minimises search times
- Simple integration in bott vario3 in-vehicle equipment and bott workshop equipment via moulded guide rail slots
- Multifunctional T-LOC: close, open, connect - with just one twist
- 2 integrated label holders on the front of the case (bank card format)
- Can be stacked and linked to many other Systainer products
- Load capacity: 20 kg



Description	Systainer ³ Organizer M 89	Systainer ³ Organizer L 89
Assembly	Empty	Empty
Dimensions W x D x H [mm]	396 x 296 x 89	508 x 296 x 89
Weight [kg]	1.60	2.08
Order ref.	72520001.19V	72520002.19V



Systainer³ organizer M + L case systems

Systainer³ organizer with small parts storage boxes



- Practical and sturdy system case for the secure storage and transport of small parts and consumables
- Equipped with small parts storage boxes
- Transparent lid allows you to see the contents and minimises search times
- Simple integration in bott vario3 in-vehicle equipment and bott workshop equipment via moulded guide rail slots
- Multifunctional T-LOC: close, open, connect - with just one twist
- 2 integrated label holders on the front of the case (bank card format)
- Can be stacked and linked to many other systainer products
- Load capacity: 20 kg



Description	Systainer ³ Organizer M 89	Systainer ³ Organizer M 89	Systainer ³ Organizer M 89	Systainer ³ Organizer M 89
Assembly	5 boxes	12 boxes	18 boxes	28 boxes
Dimensions W x D x H [mm]	396 x 296 x 89	396 x 296 x 89	396 x 296 x 89	396 x 296 x 89
Weight [kg]	1.98	2.05	2.39	2.51
Order ref.	72520092.19V	72520021.19V	72520022.19V	72520023.19V



Description	Systainer ³ Organizer L 89	Systainer ³ Organizer L 89	Systainer ³ Organizer L 89	Systainer ³ Organizer L 89
Assembly	7 boxes	13 boxes	20 boxes	33 boxes
Dimensions W x D x H [mm]	508 x 296 x 89	508 x 296 x 89	508 x 296 x 89	508 x 296 x 89
Weight [kg]	2.62	2.65	2.77	2.93
Order ref.	72520093.19V	72520024.19V	72520025.19V	72520026.19V

Systainer³ organizer M + L case systems

Divider kit with 7 boxes for Systainer³ Organizer M/L 89



- With 7 small parts storage boxes:
- 1 x 100x350x68
- 3 x 100x150x68
- 1 x 100x100x68
- 2 x 75x150x68

Dimensions W x D x H [mm]	450 x 250 x 64
Weight [kg]	0.50
Order ref.	73020116.16V

Systainer³ Organizer with nozzle insert and small parts storage boxes



- Practical and sturdy system case for the secure storage and transport of small parts and consumables
- Equipped with foam inlays and small parts storage boxes for the safe and clear storage of torch nozzles
- Transparent lid allows you to see the contents and minimises search times
- Simple integration in bott vario3 van racking and bott workshop equipment thanks to moulded guide rail slots
- Multifunctional T-LOC: close, open, connect - with just one twist
- Marking possibility thanks to 2 integrated label holders on the front of the case (bank card format)
- Can be stacked and linked to many other systainer products
- Load capacity: 20 kg



Description	Systainer Organizer ³ M 89	Systainer Organizer ³ M 89	Systainer Organizer ³ L 89
Assembly	Nozzle insert for 54 nozzles 2 boxes	Nozzle insert for 81 nozzles 4 boxes	Nozzle insert for 81 nozzles 2 boxes
Dimensions W x D x H [mm]	396 x 296 x 89	396 x 296 x 89	508 x 296 x 89
Weight [kg]	2.00	2.00	2.39
Order ref.	72520082.19V	72520083.19V	72520084.19V

Systainer³ organizer M + L case systems

Nozzle insert for Systainer³ Organizer M 89/L 89

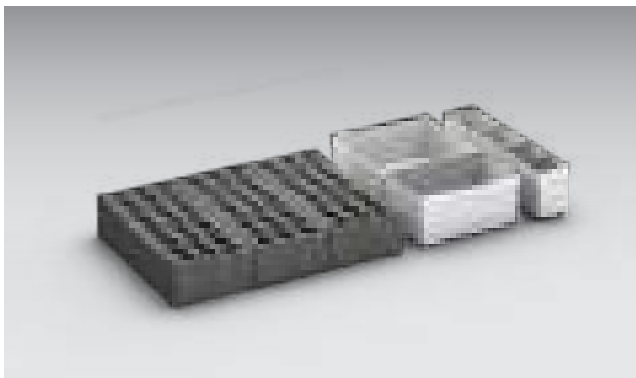

- For equipping Systainer³ Organizer M 89 and L 89 empty case
- For the safe and clear storage of torch nozzles
- Comprises 3x nozzle insert for 81 nozzles and 6x small parts storage boxes
- Nozzle insert anthracite, small parts storage boxes plastic, light grey

Dimensions W x D x H [mm]	300 x 250 x 125
Weight [kg]	0.40
Order ref.	73020115.19V

Systainer³ Organizer M89 load restraint case with fitting



- Ideal for vehicles with bott vario3 in-vehicle equipment with integrated lashing points and/or lashing rails
- The use of lashing straps with fittings allows transported goods to be secured in a fast and reliable way using the lashing points or lashing rails of the vehicle
- Set consisting of:
 - 1x Systainer³ Organizer M 89
 - 2 x lashing strap 3.5 m with fitting and cam buckle
 - 2 x lashing strap 3.5 m with fitting and ratchet
 - 6x load restraint pad
 - 6x strap protection pad
- Including important information on load restraint

Dimensions W x D x H [mm]	396 x 296 x 89
Weight [kg]	3.66
Order ref.	72610038.19V

Systainer³ organizer M + L case systems

Systainer³ Organizer M89 load restraint case with hook



- Ideal for vehicles with bott vario3 in-vehicle equipment with integrated lashing points and/or lashing rails
- The use of lashing straps with fittings allows transported goods to be secured in a fast and reliable way by means of the lashing points or lashing rails of the vehicle
- Set consisting of:
 - 1x Systainer³ Organizer M 89
 - 2 x lashing strap 3.5 m with fitting -oo- and cam buckle
 - 2 x lashing strap 3.5 m with fitting -oo- and ratchet
 - 6x load restraint pad
 - 6x strap protection pad
 - 4x fitting with bott logo 500 daN
- Including important information on load restraint

Dimensions W x D x H [mm]	396 x 296 x 89
Weight [kg]	3.66
Order ref.	72610039.19V



Systainer³ ToolBox M + L case systems

Systainer³ ToolBox



- Practical and sturdy carry box for the secure storage and transport of machines, hand tools, small parts and consumables
- No restriction of the storage space by a lid, therefore also suitable for transporting bulky goods
- Simple integration in bott vario3 in-vehicle equipment and bott workshop equipment thanks to moulded guide rail slots
- Multifunctional T-LOC: close, open, connect with just one twist
- Marking possibility thanks to 2 integrated label holders on the front of the case (bank card format)
- Can be stacked and linked to all other systainer products
- Load bearing capacity (single): 20 kg
- Load bearing capacity (when connected): 40 kg
- Material: ABS



Description	Systainer ³ ToolBox M 137	Systainer ³ ToolBox M 187	Systainer ³ ToolBox M 237
Assembly	Empty	Empty	Empty
Dimensions W x D x H [mm]	396 x 296 x 137	396 x 296 x 187	396 x 296 x 237
Weight [kg]	1.30	1.56	1.70
Order ref.	72520063.19V	72520064.19V	72520065.19V



Description	Systainer ³ ToolBox L 137	Systainer ³ ToolBox L 187	Systainer ³ ToolBox L 237
Assembly	Empty	Empty	Empty
Dimensions W x D x H [mm]	508 x 296 x 137	508 x 296 x 187	508 x 296 x 237
Weight [kg]	1.90	2.09	2.40
Order ref.	72520068.19V	72520069.19V	72520070.19V

Systainer³ ToolBag M

bott Systainer³ ToolBag M



- With carry handle, adjustable shoulder strap and a velcro patch with Bott embroidery at the side
- Inside two 12-fold and two 4-fold tool pockets and a universal bag
- Labelling possible thanks to a card slot in standardised credit card format at the front
- Load capacity 20 kg
- Easy integration into bott vario3 van racking systems and bott workplace storage equipment thanks to lateral guide rail holders
- Material: Polyester

Dimensions W x D x H [mm]	400 x 300 x 370
Weight [kg]	3.66
Order ref.	72520095.19V

bott Systainer³ M 287 Combi



- Systainer³ M in combination with spacious 80 mm high drawer
- To transport machines and their accessories
- Power and hand tools are safely stowed at the top, accessories at the bottom
- Load capacity 20 kg
- Easy integration into bott vario3 van racking systems and bott workplace storage equipment thanks to lateral guide rail holders

Version	M 287 Combi
Dimensions W x D x H [mm]	396 x 296 x 290
Weight [kg]	3.54
Pack of	1
Order ref.	72520096.19V

varioCase M case systems

varioCase M empty



- Lightweight and high-quality service case for customised configuration
- Simple integration in bott vario3 in-vehicle equipment and bott workshop equipment via moulded guide rail slots
- Lid automatically locks when closed preventing accidental spills
- Load capacity: 20 kg
- Material: anodised aluminium



Description	varioCase M 84	varioCase M 135
Assembly	Empty	Empty
Dimensions W x D x H [mm]	396 x 337 x 84	396 x 337 x 135
Weight [kg]	1.39	1.64
Order ref.	72511001.97V	72511003.97V

varioCase M empty



- Sturdy and high-quality service case for customised configuration
- Simple integration in bott vario3 in-vehicle equipment and bott workshop equipment via moulded guide rail slots
- Lid automatically locks when closed preventing accidental spills
- Load capacity: 20 kg
- Material: powder coated sheet steel
- Colour: anthracite grey (RAL 7016)



Description	varioCase M 84	varioCase M 135
Assembly	Empty	Empty
Dimensions W x D x H [mm]	396 x 337 x 84	396 x 337 x 135
Weight [kg]	2.75	3.16
Order ref.	72511005.19V	72511007.19V

varioCase M case systems

varioCase M with dividers and cross dividers



- Lightweight and high-quality service case equipped with dividers and cross dividers
- For the tidy and clear storage of tools and consumables
- Simple integration in bott vario3 in-vehicle equipment and bott workshop equipment via moulded guide rail slots
- Lid automatically locks when closed preventing accidental spills
- Load capacity: 20 kg
- Material: anodised aluminium



Description	varioCase M 84	varioCase M 135
Assembly	2x divider / 5x cross divider	2x divider / 5x cross divider
Dimensions W x D x H [mm]	396 x 337 x 84	396 x 337 x 135
Weight [kg]	1.82	2.34
Order ref.	72511013.97V	72511015.97V

varioCase M with dividers and cross dividers



- Sturdy and high-quality service case equipped with dividers and cross dividers
- For the tidy and clear storage of tools and consumables
- Simple integration in bott vario3 in-vehicle equipment and bott workshop equipment via moulded guide rail slots
- Lid automatically locks when closed preventing accidental spills
- Load capacity: 20 kg
- Material: powder coated sheet steel
- Colour: anthracite grey (RAL 7016)



Description	varioCase M 84	varioCase M 135
Assembly	2x divider / 5x cross divider	2x divider / 5x cross divider
Dimensions W x D x H [mm]	396 x 337 x 84	396 x 337 x 135
Weight [kg]	3.18	3.86
Order ref.	72511014.19V	72511016.19V

varioCase M case systems

varioCase M 84 with assortments of boxes



- Lightweight and high-quality service case equipped with small parts storage boxes
- For the tidy and clear storage of small parts and consumables
- Simple integration in bott vario3 in-vehicle equipment and bott workshop equipment via moulded guide rail slots
- Lid automatically locks when closed preventing accidental spills
- Load capacity: 20 kg
- Material: anodised aluminium



Description	varioCase M 84	varioCase M 84	varioCase M 84	varioCase M 84
Assembly	11 boxes	17 boxes	24 boxes	32 boxes
Dimensions W x D x H [mm]	396 x 337 x 84	396 x 337 x 84	396 x 337 x 84	396 x 337 x 84
Weight [kg]	1.93	1.99	2.12	2.20
Order ref.	72511017.97V	72511018.97V	72511020.97V	72511021.97V

varioCase M 84 with assortments of boxes



- Sturdy and high-quality service case equipped with small parts storage boxes
- For the tidy and clear storage of small parts and consumables
- Simple integration in bott vario3 in-vehicle equipment and bott workshop equipment via moulded guide rail slots
- Lid automatically locks when closed preventing accidental spills
- Load capacity: 20 kg
- Material: powder coated sheet steel
- Colour: anthracite grey (RAL 7016)

Dimensions W x D x H [mm]	396 x 337 x 84
Weight [kg]	3.34
Order ref.	72511019.19V

varioCase M case systems

varioCase M 135 with assortments of boxes



- Lightweight and high-quality service case equipped with small parts storage boxes
- For the tidy and clear storage of small parts and consumables
- Ample storage space thanks to second storage level with box tray
- Simple integration in bott vario3 in-vehicle equipment and bott workshop equipment via moulded guide rail slots
- Lid automatically locks when closed preventing accidental spills
- Load capacity: 20 kg
- Material: anodised aluminium

Dimensions W x D x H [mm]	396 x 337 x 135
Weight [kg]	3.24
Order ref.	72511022.97V

varioCase M 84 with nozzle insert



- Lightweight and high-quality service case equipped with nozzle insert and small parts storage boxes
- For the safe and clear storage of oil burner nozzles
- Simple integration in bott vario3 in-vehicle equipment and bott workshop equipment via moulded guide rail slots
- Lid automatically locks when closed preventing accidental spills
- Load capacity: 20 kg
- Material: anodised aluminium

Dimensions W x D x H [mm]	396 x 337 x 84
Weight [kg]	2.28
Order ref.	72511029.97V

varioCase L case systems

varioCase L empty



- Lightweight and high-quality service case for customised configuration
- Simple integration in bott vario3 in-vehicle equipment and bott workshop equipment via moulded guide rail slots
- Lid automatically locks when closed preventing accidental spills
- Load capacity: 20 kg
- Material: anodised aluminium



Description	varioCase L 84	varioCase L 135
Assembly	Empty	Empty
Dimensions W x D x H [mm]	508 x 337 x 84	508 x 337 x 135
Weight [kg]	1.65	1.94
Order ref.	72511002.97V	72511004.97V

varioCase L empty



- Sturdy and high-quality service case for customised configuration
- Simple integration in bott vario3 in-vehicle equipment and bott workshop equipment via moulded guide rail slots
- Lid automatically locks when closed preventing accidental spills
- Load capacity: 20 kg
- Material: powder coated sheet steel
- Colour: anthracite grey (RAL 7016)



Description	varioCase L 84	varioCase L 135
Assembly	Empty	Empty
Dimensions W x D x H [mm]	508 x 337 x 84	508 x 337 x 135
Weight [kg]	3.42	3.91
Order ref.	72511006.19V	72511008.19V

varioCase L case systems

varioCase L with dividers and cross dividers



- Lightweight and high-quality service case equipped with dividers and cross dividers
- For the tidy and clear storage of tools and consumables
- Simple integration in bott vario3 in-vehicle equipment and bott workshop equipment via moulded guide rail slots
- Lid automatically locks when closed preventing accidental spills
- Load capacity: 20 kg
- Material: anodised aluminium



Description	varioCase L 84	varioCase L 135
Assembly	3x divider / 6x cross divider	3x divider / 6x cross divider
Dimensions W x D x H [mm]	508 x 337 x 84	508 x 337 x 135
Weight [kg]	2.26	2.91
Order ref.	72511009.97V	72511011.97V

varioCase L with dividers and cross dividers



- Sturdy and high-quality service case equipped with dividers and cross dividers
- For the tidy and clear storage of tools and consumables
- Simple integration in bott vario3 in-vehicle equipment and bott workshop equipment via moulded guide rail slots
- Lid automatically locks when closed preventing accidental spills
- Load capacity: 20 kg
- Material: powder coated sheet steel
- Colour: anthracite grey (RAL 7016)



Description	varioCase L 84	varioCase L 135
Assembly	3x divider / 6x cross divider	3x divider / 6x cross divider
Dimensions W x D x H [mm]	508 x 337 x 84	508 x 337 x 135
Weight [kg]	4.02	4.88
Order ref.	72511010.19V	72511012.19V

varioCase L case systems

varioCase L 84 with assortments of boxes



- Lightweight and high-quality service case equipped with small parts storage boxes
- For the tidy and clear storage of small parts and consumables
- Simple integration in bott vario3 in-vehicle equipment and bott workshop equipment via moulded guide rail slots
- Lid automatically locks when closed preventing accidental spills
- Load capacity: 20 kg
- Material: anodised aluminium



Description	varioCase L 84	varioCase L 84	varioCase L 84	varioCase L 84
Assembly	12 boxes and tool compartment	17 boxes and tool compartment	24 boxes and tool compartment	32 boxes and tool compartment
Dimensions W x D x H [mm]	508 x 337 x 84	508 x 337 x 84	508 x 337 x 84	508 x 337 x 84
Weight [kg]	2.30	2.38	2.52	2.59
Order ref.	72511023.97V	72511024.97V	72511026.97V	72511027.97V

varioCase L 84 with assortments of boxes



- Sturdy and high-quality service case equipped with small parts storage boxes
- For the tidy and clear storage of small parts and consumables
- Simple integration in bott vario3 in-vehicle equipment and bott workshop equipment via moulded guide rail slots
- Lid automatically locks when closed preventing accidental spills
- Load capacity: 20 kg
- Material: powder coated sheet steel
- Colour: anthracite grey (RAL 7016)

Dimensions W x D x H [mm]	508 x 337 x 84
Weight [kg]	4.15
Order ref.	72511025.19V

varioCase L case systems

varioCase L 135 with assortments of boxes



- Lightweight and high-quality service case equipped with small parts storage boxes
- For the tidy and clear storage of small parts and consumables
- Ample storage space thanks to second storage level with box tray
- Simple integration in bott vario3 in-vehicle equipment and bott workshop equipment via moulded guide rail slots
- Lid automatically locks when closed preventing accidental spills
- Load capacity: 20 kg
- Material: anodised aluminium

Dimensions W x D x H [mm]	508 x 337 x 135
Weight [kg]	3.88
Order ref.	72511028.97V

varioCase L 84 with nozzle insert



- Lightweight and high-quality service case equipped with nozzle insert and small parts storage boxes
- For the safe and clear storage of oil burner nozzles
- Simple integration in bott vario3 in-vehicle equipment and bott workshop equipment via moulded guide rail slots
- Lid automatically locks when closed preventing accidental spills
- Load capacity: 20 kg
- Material: anodised aluminium

Dimensions W x D x H [mm]	508 x 337 x 84
Weight [kg]	2.68
Order ref.	72511030.97V

Aluminium transport cases

Aluminium transport cases



- Load capacity: 35 kg per handle
- Large-sized handles
- Snap lock for attaching padlocks
- Lid with stacking corners with guards
- Lid with rubber sealing profile on all sides
- Compatible with europallets



Version	A 620	A 640
Dimensions W x D x H [mm]	585 x 385 x 250	585 x 385 x 410
Weight [kg]	4.28	5.04
Pack of	1	1
Order ref.	02501001	02501002



Version	A 833	A 840	A 860
Dimensions W x D x H [mm]	785 x 385 x 340	785 x 585 x 410	785 x 585 x 610
Weight [kg]	5.80	7.70	9.12
Pack of	1	1	1
Order ref.	02501003	02501004	02501005

Steel tool chests

Steel tool chests



- Heavy duty storage box made of durable and resistant welded sheet steel for a wide range of applications, e.g. for storing assembly materials and tools
- Removable tool tray in which small parts can be kept organised and clearly arranged
- Option to attach a padlock to protect the contents of the box from unauthorised access
- Practical hinged lid with drop handles to easily lift and carry the box
- U-versions with hardboard lining to protect the box and contents from accidental damage

Version	P640
Dimensions W x D x H [mm]	640 x 250 x 235
Weight [kg]	5.89
Order ref.	02502020.19V

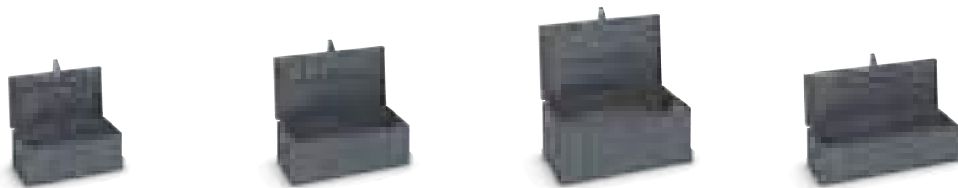

Version	U 700	U 830	U 910	U 1000
Dimensions W x D x H [mm]	720 x 392 x 300	860 x 472 x 332	939 x 562 x 424	1015 x 400 x 300
Weight [kg]	14.82	20.20	26.79	18.00
Order ref.	02502021.19V	02502022.19V	02502023.19V	02502024.19V



Euroboxes



- Resistant to numerous acids and alkalis
- Temperature resistance -20 °C to +60 °C, for a short time also up to +90 °C
- Material: Polypropylene
- Colour: anthracite grey



Version	S 120	M 120	M 175
Dimensions W x D x H [mm]	200 x 300 x 120	400 x 300 x 120	400 x 300 x 175
Weight [kg]	0.42	0.69	0.95
Pack of	1	1	1
Order ref.	62510019.19V	62510013.19V	62510020.19V



Version	M 235	M 320	L 120
Dimensions W x D x H [mm]	400 x 300 x 235	400 x 300 x 320	600 x 400 x 120
Weight [kg]	1.15	1.59	1.17
Pack of	1	1	1
Order ref.	62510014.19V	62510015.19V	62510016.19V



Version	L 175	L 220	L 320
Dimensions W x D x H [mm]	600 x 400 x 175	600 x 400 x 220	600 x 400 x 320
Weight [kg]	1.46	1.67	2.52
Pack of	1	1	1
Order ref.	62510021.19V	62510017.19V	62510018.19V

Euroboxes

Cover for euroboxes



- Containers fit standard europallet sizes
- For all storage, production and transport needs
- Straight walls offer maximum volume with excellent strength
- Optional lids available
- Resistant to numerous acids and alkalis
- Temperature resistance -20 °C to +60 °C, for a short time also up to +90 °C
- Material: Polypropylene
- Colour: anthracite grey



Dimensions W x D x H [mm]	400 x 300 x 27	600 x 400 x 27
Weight [kg]	1.17	2.28
Pack of	3	3
Order ref.	12204064	12204065





Does what it says on the tin

Your load space also offers lots of potential away from van racking systems. Our load restraint accessories ensure that you can make the most of the space in a practical and safe way. Lashing straps, nets and other lashing equipment are just a few of the aids that make safe transport easier for you – and we have a suitable storage solution for them for when they are not in use.

Not all loads can be secured easily in a conventional way – so we have developed our own solutions for a few special applications. This chapter also includes products that allow you to use somewhat unusual areas of your load space as storage space, such as the rear doors and the partition to the driver cab.





Lashing points where you need them

A bott vario3 van racking system can store a lot – and it is a practical lashing aid at the same time. Whether configured respectively from the word go or retrofitted later, the stable aluminium frame is the perfect carrier for lashing points where you need them.

bott. mastering space and time.

Load restraint

Load restraint pads with holder

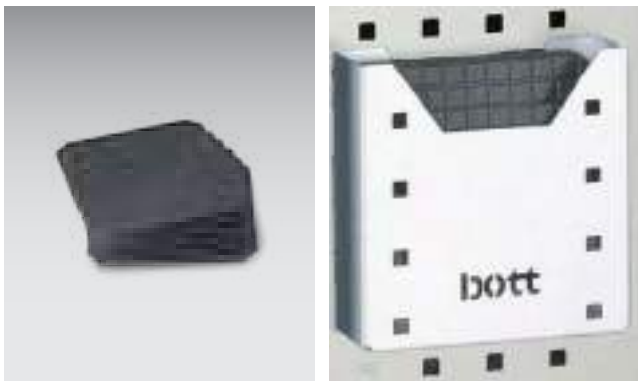

- Load restraint kit for securing loaded goods
- Coefficient of friction in line with VDI guideline 2700 (DEKRA test certificate supplied)
- Flame resistant (fire class BflS1 in accordance with EN 13501)
- Antislip, dimensionally stable, tear resistant, durable, waterproof, oil and fat resistant, washable up to 60°C
- Colour: anthracite grey (RAL 7016)
- Optionally available with anodised aluminium storage pocket (160 x 45 x 160 mm)

Version	incl. holder	-	Holder only
Dimensions W x D x H [mm]	160 x 45 x 160	152 x 152 x 5	160 x 45 x 160
Weight [kg]	0.60	0.20	0.21
Pack of	6	6	
Order ref.	61302006.19V	61302007.19V	62530007.97V

Strap protection pads with holder

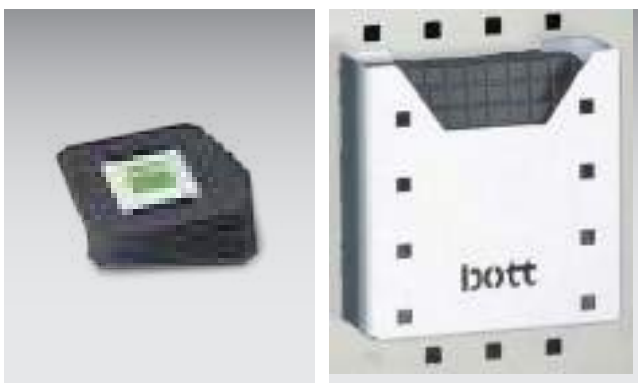

- Edge protection for the load, with openings for threading the lashing strap
- Coefficient of friction in line with VDI guideline 2700 (DEKRA test certificate supplied)
- Flame resistant (fire class Bfl-S1 in accordance with EN 13501)
- Anti-slip, dimensionally stable, tear resistant, robust, waterproof, resistant to oil and grease, washable up to 60°C
- Colour: anthracite grey (RAL 7016)
- Optionally available with anodised aluminium storage pocket (160 x 45 x 160 mm)

Version	Incl. holder	-	Holder only
Dimensions W x D x H [mm]	160 x 45 x 160	152 x 152 x 5	160 x 45 x 160
Weight [kg]	0.60	0.20	0.21
Pack of	6	6	
Order ref.	61302009.19V	61302010.19V	62530007.97V

Load restraint

Load restraint mat with holder



- For securing loaded goods
- Coefficient of friction in line with VDI guideline 2700 (DEKRA test certificate supplied)
- Flame resistant (fire class BflS1 in accordance with EN 13501)
- Antislip, dimensionally stable, tear resistant, durable, waterproof, oil and fat resistant, washable up to 60°C
- Colour: anthracite grey (RAL 7016)
- Optionally available with anodised aluminium storage pocket (114 x 114 x 500 mm)

Version	Incl. holder	-	Incl. holder	-
Dimensions W x D x H [mm]	620 x 820 x 5	620 x 820 x 5	1220 x 820 x 5	1220 x 820 x 5
Net weight [kg]	1.50	0.70	2.10	1.30
Order ref.	61302001.19V	61302002.19V	61302003.19V	61302004.19V

Floor mat



- Roll width 600 mm
- Anti-slip, dimensionally stable, tear-resistant, robust
- Colour: anthracite grey (RAL 7016)
- PES glass yarn fabric with PVC coating on both sides and additional interspersed PVC granulate

Length [mm]	2500	3300	10000
Weight [kg]	3.05	3.90	12.00
Order ref.	11305066	11305067	11305041

Load restraint

Lashing rails with protective profile

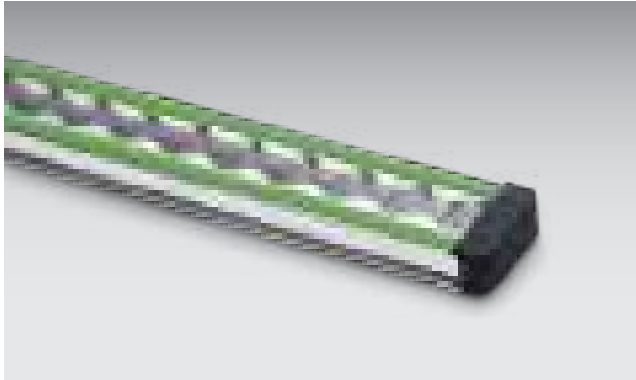

- Contact surfaces with anti-abrasion protection, ideal for transporting goods with delicate substances
- For straps with fitting
- Width 46 mm
- Strap attachment points every 25 mm
- Load capacity up to 500 daN (depending on the type of fixing)
- The green protective strip can be replaced by LED strips
- Incl. 2 end caps as protection

Rail length [mm]	425	525	715	825
Weight [kg]	0.40	0.50	0.61	0.78
Order ref.	67901057.98V	67901058.98V	67901042.98V	67901059.98V

Rail length [mm]	945	1075	1500	2000
Weight [kg]	0.83	1.00	1.30	1.72
Order ref.	67901014.98V	67901060.98V	67901015.98V	67901016.98V

Rail length [mm]	3000	RTM
Weight [kg]	2.58	0.87
Order ref.	67901017.98V	67901018.98V

Version	End cap for rail with protective strip
Dimensions W x D x H [mm]	20 x 18 x 46
Weight [kg]	0.01
Pack of	2
Order ref.	85001138.19V

bott vario load securing rail plus

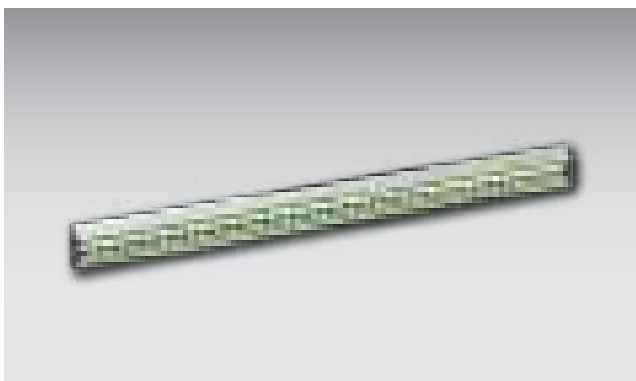

- Horizontal aluminium wall lashing rail with anti-rub strips and end caps for lateral assembly to the vehicle bows in the load compartment
- Wall lashing rail with airline lashing points in 25 mm increments and green anti-rub strips
- Replaces wall lashing rail variable item no. 07903374.17V
- Material: aluminium

Dimensions W x D x H [mm]	... x 30 x 75
Weight [kg]	1.71
Order ref.	67901078.19V

Load restraint

Lashing rail surface mounted



- For straps with fitting
- Width 65 mm
- Strap attachment points every 25 mm
- Load capacity up to 500 daN (depending on the type of fixing)
- Incl. 2 end caps as protection

Rail length [mm]	1000	1500	2000
Weight [kg]	0.80	1.20	1.60
Order ref.	67901001.98V	67901002.98V	67901003.98V

Rail length [mm]	3000	RTM
Weight [kg]	2.40	0.80
Order ref.	67901004.98V	67901005.98V

Version	End cap for end-frame floor rail
Weight [kg]	0.01
Order ref.	85001173.19V

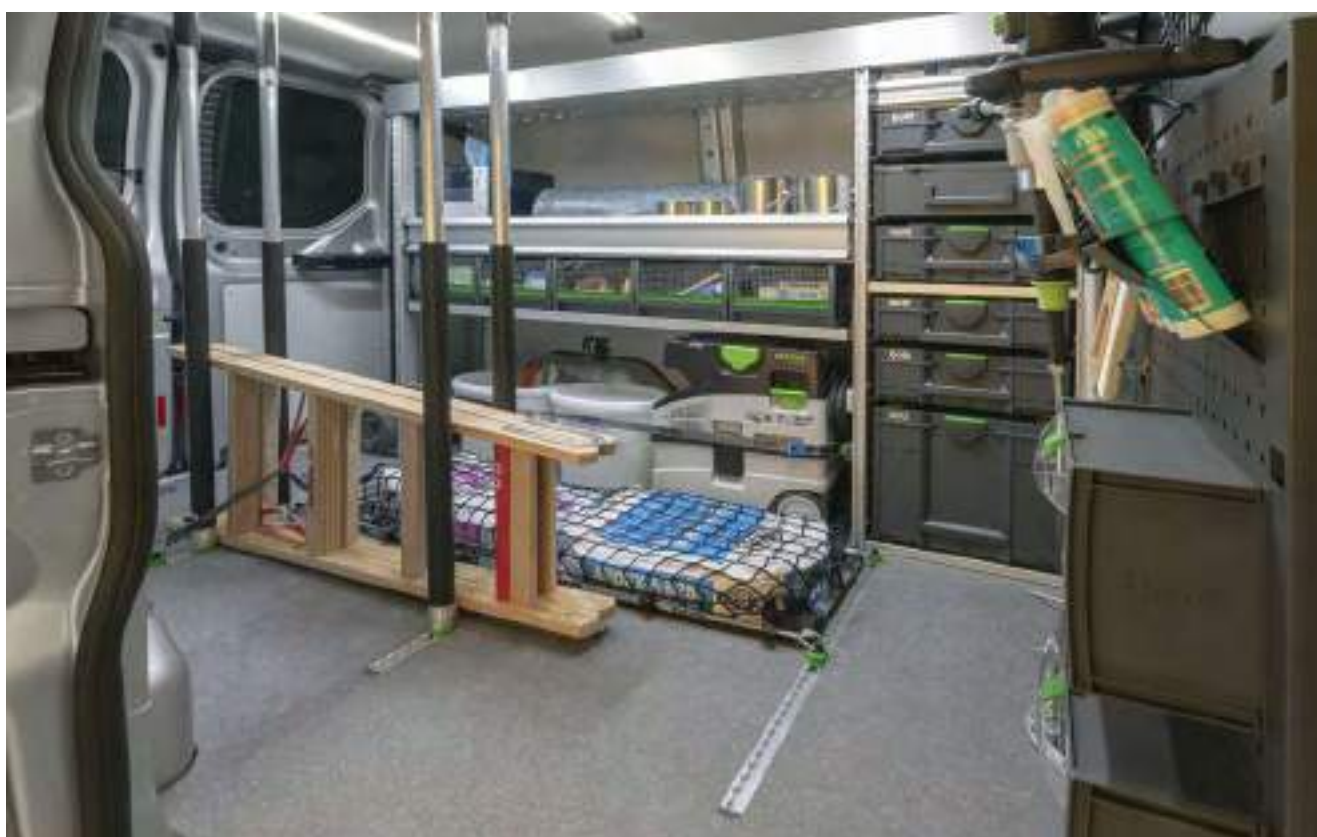

Load restraint

Lashing rail half round with end cap



- For straps with fitting
- Width 50 mm
- Strap attachment points every 25 mm
- Load capacity up to 500 daN (depending on the type of fixing)
- Incl. 2 end caps as protection

Rail length [mm]	800	1000	1200	1500
Weight [kg]	0.60	0.80	1.00	1.10
Order ref.	67901055.98V	67901008.98V	67901056.98V	67901009.98V

Rail length [mm]	2000	3000	RTM
Weight [kg]	1.50	2.30	0.80
Order ref.	67901010.98V	67901011.98V	67901012.98V

Version	End cap for semi-circular lashing rail
Dimensions W x D x H [mm]	34 x 50 x 12
Weight [kg]	0.01
Pack of	2
Order ref.	85001140.19V



Load restraint

Lashing rail raised 25 mm



- For straps with fitting
- Width 25 mm
- Strap attachment points every 25 mm
- Load bearing capacity up to 500 daN (depending on the type of fixing)
- Incl. 2 end caps as protection

Rail length [mm]	3000	RTM
Weight [kg]	1.10	0.37
Order ref.	67901034.97V	67901039.97V

Version	End cap for lashing rail 25 mm
Dimensions W x D x H [mm]	25 x 14 x 15
Weight [kg]	0.01
Pack of	2
Order ref.	85001142.19V

Lashing rail recessed

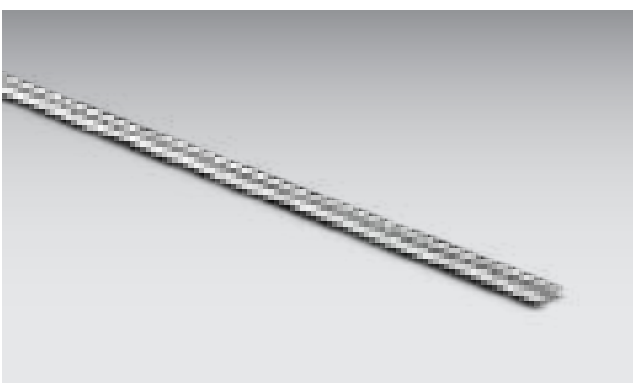

- For retrofitting to an existing floor
- Width 46 mm
- Strap attachment points every 25 mm
- Load capacity up to 500 daN (depending on the type of fixing)
- Incl. 2 end caps as protection

Rail length [mm]	3000	RTM
Weight [kg]	2.19	0.73
Order ref.	67901040.98	67901041.98

Version	End cap for lashing rail retrofit
Dimensions W x D x H [mm]	50 x 46 x 12
Weight [kg]	0.01
Pack of	2
Order ref.	85001155

Load restraint

Lashing rail with protective strip and cam-buckle strap for gas bottles



- For the safe transport of compressed gas cylinders
- Contact surfaces with anti-abrasion protection, ideal for transporting goods with delicate substances
- Width 46 mm, attachment points every 25 mm
- Incl. end caps
- With rear fixing plate
- Version with ratchet strap 1000 mm, fixed end 130 mm, load capacity up to 500 daN

Version	with 1 lashing rail and 1 ratchet strap					
System depth [[mm]	/2		/3		/4	
Rail length [mm]	264		376		488	
Weight [kg]	0.67		0.72		0.86	
Assembled/packed	Assembled	Packed	Assembled	Packed	Assembled	Packed
Order ref.	72615001.19M	72615001.19V	72615002.19M	72615002.19V	72615003.19M	72615003.19V

Lashing rail with protective strip and cam-buckle strap



- Contact surfaces with anti-abrasion protection, ideal for transporting goods with delicate substances
- Width 46 mm, attachment points every 25 mm
- Incl. end caps
- With rear fixing plate
- Version with cam-buckle strap 1000 mm, fixed end 130 mm, load capacity up to 150 daN

Version	Cam-buckle strap					
System depth [[mm]	/2		/3		/4	
Rail length [mm]	264		376		488	
Weight [kg]	0.43		0.48		0.62	
Assembled/packed	Assembled	Packed	Assembled	Packed	Assembled	Packed
Order ref.	72610043.19M	72610043.19V	72610044.19M	72610044.19V	72610045.19M	72610045.19V

Load restraint

Lashing rails with protective profile



- Contact surfaces with anti-abrasion protection, ideal for transporting goods with delicate substances
- Width 46 mm, attachment points every 25 mm
- Incl. end caps
- With rear fixing plate

System depth [[mm]	/2		/3		/4	
Rail length [mm]	264		376		488	
Weight [kg]	0.19		0.24		0.38	
Assembled/packed	Assembled	Packed	Assembled	Packed	Assembled	Packed
Order ref.	72610046.19M	72610046.19V	72610047.19M	72610047.19V	72610048.19M	72610048.19V

Lashing rail SLF-C



- For installation on the SLF C with a SLF Cover assembled
- With lashing rail SLF-C, an additional reinforcement plate must be fitted within the SLF Cover

System depth [[mm]	/3		/4	
Rail length [mm]	376		488	
Weight [kg]	0.54		0.73	
Assembled/packed	Assembled	Packed	Assembled	Packed
Order ref.	72610051.19M	72610051.19V	72610052.19M	72610052.19V

Load restraint

Lashing rail SLF-C with ratchet strap



- Contact surfaces with anti-abrasion protection, ideal for transporting goods with delicate substances
- Strap length 1000mm
- Load capacity up to 500 daN

Version	With 1 support rail and 1 ratchet strap / for SLF-C			
System depth [[mm]	/3		/4	
Rail length [mm]	376		488	
Weight [kg]	1.00		1.20	
Assembled/packed	Assembled	Packed	Assembled	Packed
Order ref.	72615007.19M	72615007.19V	72615008.19M	72615008.19V

Lashing rail with protective strip for perforated panel

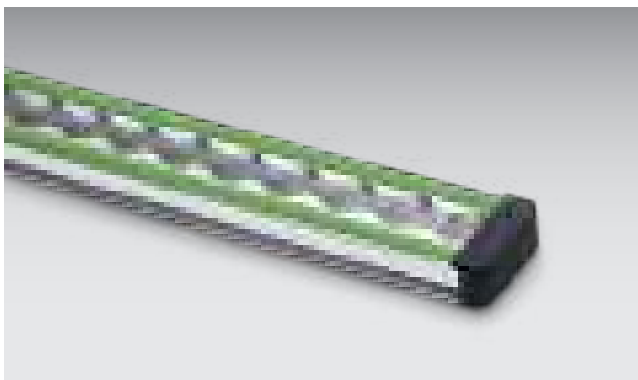

- Contact surfaces with anti-abrasion protection, ideal for transporting goods with delicate substances
- For straps with fitting
- Width 46 mm
- Strap attachment points every 25 mm
- Load capacity up to 500 daN (depending on the type of fixing)
- The green protective strip can be replaced by LED strips
- Incl. 2 end caps as protection

Rail length [mm]	425	525	715	825
Weight [kg]	0.40	0.50	0.61	0.78
Order ref.	67901057.98V	67901058.98V	67901042.98V	67901059.98V

Rail length [mm]	945	1075	1125
Weight [kg]	0.83	1.00	0.93
Order ref.	67901014.98V	67901060.98V	67901066.98V

Version	End cap for rail with protective strip
Dimensions W x D x H [mm]	20 x 18 x 46
Weight [kg]	0.01
Pack of	2
Order ref.	85001138.19V

Load restraint

Lashing strap with auto-wind



- For quick and easy load restraint
- Variant without fixed length strap end must be bolted to in-vehicle equipment module
- Black strap
- Strap width 25 mm
- Strap length 2000 mm

Version	Hook – Hook	Fitting – to be bolted on	Fitting – Fitting	Fitting - to be bolted on, with lashing rail 1000 mm
Fixed end [mm]	200	–	200	-
Load capacity [daN]	125	125	125	125
Weight [kg]	0.70	0.70	0.75	1.50
Order ref.	62626062.90	62626061.90	62626065.90	67901019.98V

Ratchet strap with fitting



- bott branded strap in anthracite grey
- Suitable for lashing rails
- Strap width 25 mm
- Load capacity up to 500 daN

Strap length [mm]	1000	2500
Fixed end [mm]	130	130
Load capacity [daN]	500	500
Weight [kg]	0.55	0.64
Order ref.	62626005.19V	62626006.19V

Strap length [mm]	2500	3500	5000
Fixed end [mm]	500	500	500
Load capacity [daN]	500	500	500
Weight [kg]	0.64	0.69	0.78
Order ref.	62626049.19V	62626007.19V	62626008.19V

Load restraint

Version with load capacity up to 400 daN

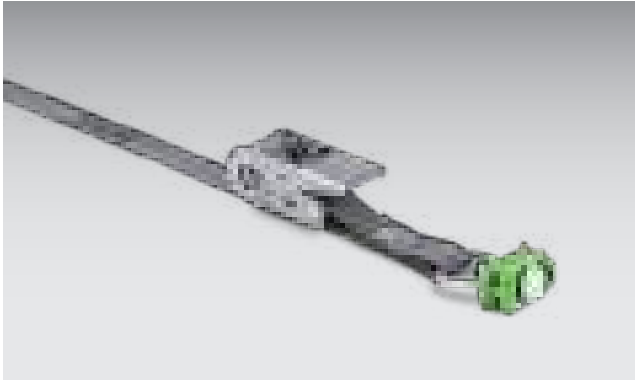

- bott belt webbing in anthracite grey
- Suitable for lashing rails
- Webbing width 25 mm
- Load capacity up to 400 daN

Strap length [mm]	3000
Fixed end [mm]	130
Load capacity [daN]	400
Weight [kg]	0.36
Order ref.	62626069.19V

Ratchet strap with fitting and cam-buckle

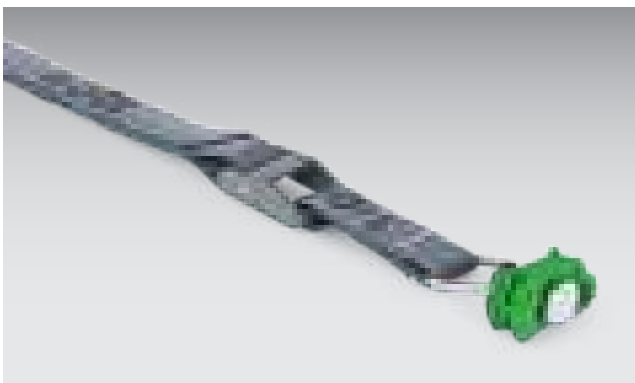

- bott branded strap in anthracite grey
- Suitable for lashing rails
- Strap width 25 mm
- Load capacity up to 150 daN

Strap length [mm]	1000	2500	2500
Fixed end [mm]	130	130	500
Load capacity [daN]	150	150	150
Weight [kg]	0.21	0.26	0.26
Order ref.	62626009.19V	62626010.19V	62626050.19V

Strap length [mm]	3500	5000
Fixed end [mm]	500	500
Load capacity [daN]	150	150
Weight [kg]	0.30	0.35
Order ref.	62626011.19V	62626012.19V

Load restraint

Ratchet strap with hook end



- bott branded strap in anthracite grey
- Universal hook for use with lashing eyes
- Strap width 25 mm

Strap length [mm]	3000	5000
Fixed end [mm]	130	500
Load capacity [daN]	400	650
Weight [kg]	0.38	0.90
Order ref.	62626067.19V	62626033.19V



Load restraint

Ratchet strap with snap hook



- bott branded strap in anthracite grey
- Strap width 25 mm

Strap length [mm]	2500	3500	5000
Fixed end [mm]	250	500	500
Load capacity [daN]	650	650	650
Weight [kg]	0.61	0.65	0.73
Order ref.	62626075.19	62626076.19	62626077.19

Strap length [mm]	2500	3500	5000
Fixed end [mm]	250	500	500
Load capacity [daN]	150	150	150
Weight [kg]	0.29	0.31	0.35
Order ref.	62626081.19	62626082.19	62626083.19

Lashing strap with wide belt size and hook end

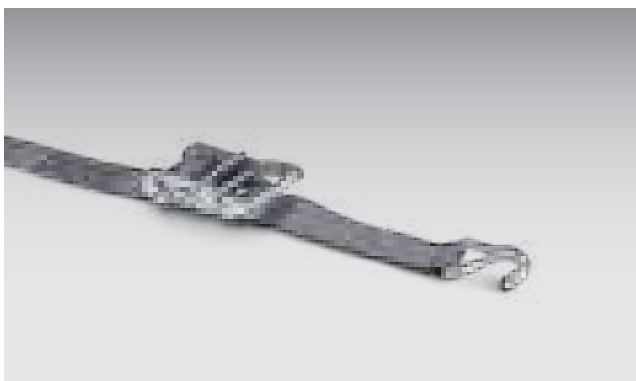

- bott branded lashing strap in anthracite grey
- Strap width 50 mm

Strap length [mm]	5000
Fixed end [mm]	500
Load capacity [daN]	750
Weight [kg]	1.10
Order ref.	62626089.19

Load restraint

Lashing strap with wide belt size and snap hook



- bott branded lashing strap in anthracite grey
- Strap width 50 mm

Strap length [mm]	5000
Fixed end [mm]	500
Load capacity [daN]	750
Weight [kg]	1.15
Order ref.	62626091.19

Cam-buckle strap with plastic hooks



- With cam buckle
- Colour: anthracite grey (RAL 7016)



Strap length [mm]	2500
Fixed end [mm]	500
Weight [kg]	0.18
Order ref.	62626043.19V

Load restraint

Ratchet strap

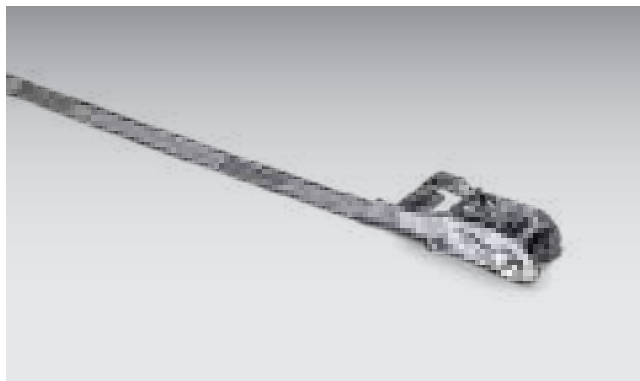

- bott branded strap in anthracite grey
- Strap width 25 mm

Strap length [mm]	1000	2500
Load capacity [daN]	1000	1000
Weight [kg]	0.36	0.47
Order ref.	62626071.19	62626072.19

Strap with cam buckle

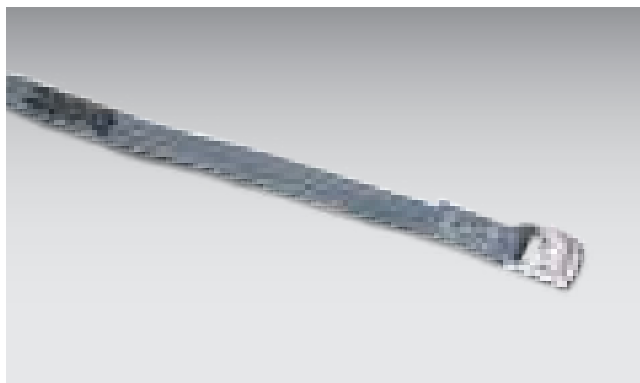

- bott branded strap in anthracite grey
- Strap width 25 mm

Strap length [mm]	1000	2500
Load capacity [daN]	300	300
Weight [kg]	0.08	0.13
Order ref.	62626037.19V	62626039.19V

Load restraint

Ratchet strap with flat hook ends



- bott belt webbing in anthracite grey
- For cargo restraint track
- Webbing width 25 mm

Strap length [mm]	3500
Fixed end [mm]	500
Load capacity [daN]	500
Weight [kg]	0.69
Order ref.	62626022.19V



Load restraint

bott vario strap set



- 4x strap with cam-buckle, length: 400 mm
- 2x lashing strap with fitting and cam-buckle, length: 2500 mm, fixed end: 130 mm
- Used for varioCar boot floor insert

Weight [mm]	0.67
Order ref.	12626087.90V

Fitting



- Suitable for use with lashing rails / lashing plate
- Load capacity up to 500 daN

Dimensions W x D x H [mm]	43 x 26 x 65
Weight [kg]	0.05
Order ref.	63003031.51V

Load restraint

Threaded fitting with star grip



- Suitable for lashing rails
- Clamping capacity 0 - 29 mm
- Load capacity up to 500 daN
- M8 thread

Dimensions W x D x H [mm]	45 x 25 x 50
Weight [kg]	0.06
Order ref.	63003028.51V

Threaded fitting



- Suitable for use with lashing rails / lashing plate
- Load capacity up to 500 daN
- M8 thread

Version	Threaded fitting	Threaded fitting
Clamping area [mm]	0 - 5	0 - 20
Dimensions W x D x H [mm]	43 x 22 x 25	43 x 22 x 40
Weight [kg]	0.08	0.10
Pack of	2	2
Order ref.	63003092.51V	63003027.51V

Load restraint

Slot nut for Airline profile



- Sliding block for airline lashing rail with 2x M6 thread and 1x M8 thread
- Additional M8 thread in the sliding block for additional installation position for fixing different accessory materials to the airline lashing rail
- With screw and washer
- Zinc-plated

Version	Slot-nut
Pack of	2
Weight [kg]	0.09
Order ref.	63510092

Aluminium lashing plate



- For straps with fitting
- Load capacity up to 150 daN

Dimensions W x D x H [mm]	45 x 45 x 10
Weight [kg]	0.02
Order ref.	12626021

Load restraint

bott connector



- Suitable for bott lashing rails with green protective strip
- 2-piece
- Can be positioned in 25mm pitch
- Can be inserted into the lashing rail from the front
- 3x M8 thread
- Load capacity up to 500 daN
- Material: zinc-plated steel

Dimensions W x D x H [mm]	90 x 14 x 23
Weight [kg]	0.23
Pack of	2
Order ref.	63510132.51

Lashing eyes



- Sheet steel, zinc-plated
- Flush-fitting
- Including fixing kit

Version	Lashing eye	Lashing eye
Load capacity [daN]	350	800
Dimensions W x D x H [mm]	104 x 70 x 12	145 x 100 x 17
Weight [kg]	0.28	0.57
Order ref.	63003033.51V	63003034.51V

Load restraint

Recessed lashing eye



- Sheet steel, zinc-plated
- Flush-fitting
- Including fixing kit Lashing eye
- Zinc-plated steel with plastic edging
- Ø 100 mm
- Fixing kit included

Load capacity [daN]	200
Dimensions W x D x H [mm]	100 x 100 x 11
Weight [kg]	0.09
Order ref.	63003037.51V

Single lashing point -oo- for retrofitting



- Can be retrofitted in an already existing bott standard floor
- Accommodates the use of tension rods and green bott standard fitting
- Mount at the back in the floor with 3x countersunk screws
- Use a drilling tool with Ø 50 mm to create the retrofitted opening
- Pack of 1
- Aluminium

Ø [mm]	49
Length [mm]	12
Weight [kg]	0.11
Order ref.	72610061.98V

Load restraint

Traffic cone storage solution with securing strap

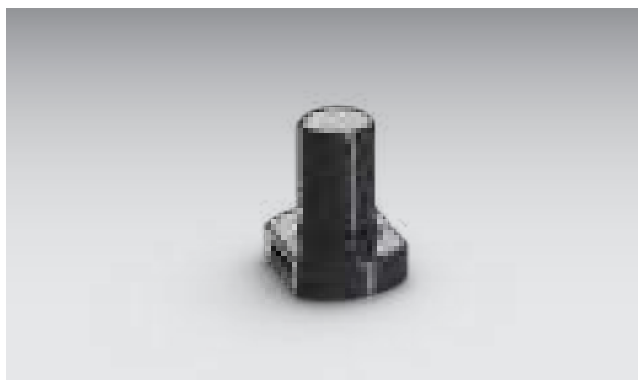

- The locating lug is used for securing stacked cones in place
- The cones are stacked on top of one another, the locating lug is inserted and secured using the lashing strap looped through the base
- Diameter of the locating lug 30 mm
- Height of the locating lug 45 mm
- Lashing strap with screw plate and cam-buckle, length 2500 mm, fixed end 200 mm, locating lug without fixing kit

Dimensions W x D x H [mm]	60 x 45 x 60
Weight [kg]	0.30
Order ref.	63510152.90V

Single lashing point -oo- Construction



- Makes quick and simple load restraint possible
- For installation on bott vario3 vehicle equipment, suitable for the T-slots on the SLF and many system components
- With perforation -oo- for lashing straps with fitting
- Single lashing eye - oo- for vertical or horizontal T-slots
- For use on end frame profiles, L-Profile or on profiles on shelves and shelf trays
- Further universal use through simple mounting in other suitable spots
- A suitable installation kit 73502076.51V must be ordered with it

Dimensions W x D x H [mm]	29 x 16 x 112
Weight [kg]	0.05
Order ref.	72610028.19V

Load restraint

C-Lash strap with single lashing eye raised

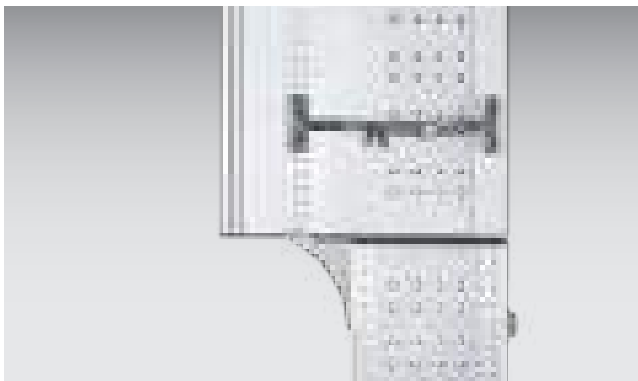

- Makes quick and simple load restraint possible
- For installation on bott vario3 van racking, at the side to the bott vario3 end frame
- Included:
 - 1x lashing strap (-C-) with cam-buckle strap
 - 2x single lashing eye (-C-) design
 - bott belt webbing in anthracite grey
 - Webbing width 25 mm

Strap length [mm]	1000	1000	2500	2500
Fixed end [mm]	100	100	100	100
Load capacity [daN]	100	100	100	100
Weight [kg]	0.13	0.13	0.16	0.16
Assembled/packed	Assembled	Packed	Assembled	Packed
Order ref.	72610034.19M	72610034.19V	72610035.19M	72610035.19V

C-Lash cam-buckle strap



- Makes quick and simple load restraint possible
- Included:
 - 1x lashing strap (-C-) with cam-buckle strap
 - bott belt webbing in anthracite grey
 - Webbing width 25 mm

Strap length [mm]	700	1000	2500
Fixed end [mm]	100	100	100
Load capacity [daN]	100	100	100
Weight [kg]	0.10	0.10	0.13
Order ref.	62626099.19V	62626095.19V	62626096.19V

Load restraint

C-Lash strap with single lashing eye recessed

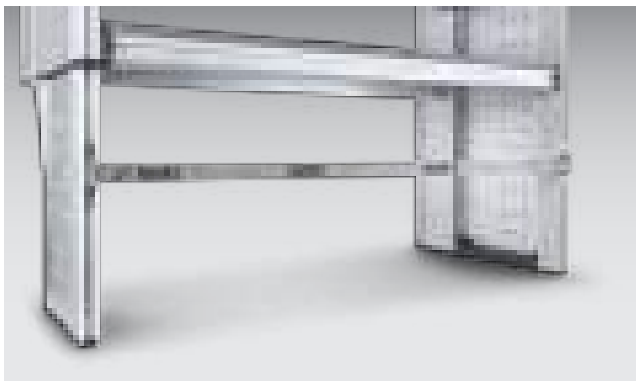

- Makes quick and simple load restraint possible
- Included:
 - 1x lashing strap (-C-) with cam-buckle strap
 - 2x single lashing eye (-C-) recessed design
 - bott belt webbing in anthracite grey
 - Webbing width 25 mm

Strap length [mm]	1000	2500
Fixed end [mm]	100	100
Load capacity [daN]	100	100
Weight [kg]	0.12	0.15
Order ref.	72610030.19V	72610031.19V

C-Lash strap with single lashing eye recessed for use between end-frames



- Makes quick and flexible load restraint possible
- Includes:
 - 1x lashing strap (-C-) with cam-buckle
 - 2x single lashing point (-C-) recessed for intermediate construction
 - bott branded strap in anthracite grey
 - Strap width 25 mm

Strap length [mm]	1000	1000	2500	2500
Fixed end [mm]	100	100	100	100
Load capacity [daN]	100	100	100	100
Weight [kg]	0.13	0.13	0.16	0.16
Assembled/packed	Assembled	Packed	Assembled	Packed
Order ref.	72610041.17M	72610041.17V	72610042.17M	72610042.17V

Load restraint

Load-restraint blanket



- For securing the load in the vehicle and on the flatbed
- Theft protection thanks to the opaque fabric
- Tested according to VDI 2700
- Load capacity up to 200 daN
- Colour: anthracite grey

Version	4x cam buckle strap with flat hook ends	4x cam buckle strap with fitting	6x cam buckle strap with flat hook ends	6x cam buckle with fitting
Dimensions W x D [mm]	1250 x 730	1250 x 730	2290 x 1500	2290 x 1500
Weight [kg]	1.20	1.20	2.50	2.50
Order ref.	62627010.19V	62627011.19V	62627012.19V	62627013.19V

Load-securing net

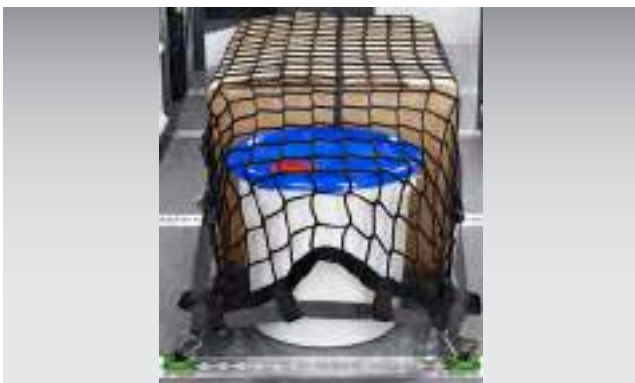

- Close-meshed knitted load-securing net
- Tested according to VDI 2700
- Mesh width 45 x 45 mm
- Load capacity up to 400 daN
- Cam-buckle strap around circumference

Version	4x hook	4x fitting	4x hook	4x fitting
Dimensions W x D [mm]	1250 x 730	1250 x 730	2290 x 1500	2290 x 1500
Weight [kg]	1.06	0.88	1.63	1.45
Order ref.	62627006.19V	62627007.19V	62627008.19V	62627009.19V

Load restraint

Load restraint net



- Load restraint net made of bott belt webbing in anthracite grey
- Tested according to VDI 2700
- Mesh size 150 x 150 mm
- Load capacity up to 800 daN
- All-round ratchet strap

Version	4x hook
Dimensions W x D [mm]	3000 x 1900
Weight [kg]	3.70
Order ref.	62627005.19V

Net hooks - pack of 7



- Net hook for installation on the drop side of the flatbed
- For fixing a cover net
- Pack of 7

Version	Net hooks - pack of 7
Dimensions W x D [mm]	39 x 21
Weight [kg]	0.23
Order ref.	72610060.51V

Load restraint accessories

Box shelf with bottBoxes



- Aluminium box shelf
- Incl. bottBoxes M2
- Max. load capacity 30 kg

Suitable for	Fiat Ducato/Peugeot Boxer/ Citroën Jumper L2/H2	Ford Transit L2/H2/H3-2014	Mercedes-Benz SprinterL2/ H1/H2	Fiat Ducato/Peugeot Boxer/ Citroën Jumper L2/H2
Dimensions W x D x H [mm]	1500 x 234 x 90	1290 x 234 x 90	1590 x 234 x 90	1500 x 234 x 90
Weight [kg]	7.00	5.62	7.09	7.00
Order ref.	62533382.19V	62533280.19V	62533276.19V	62533382.19V

Box shelf with bottBoxes for vehicle bulkhead



- For mounting directly on the vehicle bulkhead or on a perforated panel
- Aluminium box tray
- Incl. 7x bottBox M1

Dimensions W x D x H [mm]	920 x 128 x 67
Weight [kg]	1.55
Order ref.	62533403.19V

Load restraint accessories

End-frame storage tray with anti-slip mat for transverse installation



- With anti-slip mat
- For installation on the outside of the SLF on 2 transverse vario3 shelves behind one another
- Max. load capacity 30 kg
-

Dimensions W x D x H [mm]	180 x 1043 x 100	116 x 1043 x 65
Weight [kg]	1.62	1.16
Order ref.	73508004.97V	73508005.97V

End-frame storage tray variable



- For free installation on the vehicle or on the floor e.g. at the vehicle bulkhead
- For installation on the glass rack
- Incl. anti-slip mat

Dimensions W x D x H [mm]	180 x 1900-3600 x 100	180 x 803-1379 x 100
Weight [kg]	5.30	2.25
Order ref.	73508036.97V	73508029.97V

Load restraint accessories

Pallet stop



- Makes form-fit load restraint possible
- Is integrated in the floor rail
- Has two fitting brackets
- Can be connected by a shoring pole up to 1000 mm
- Load capacity per set up to 500 daN



Dimensions W x D x H [mm]	80 x 85 x 65
Weight [kg]	1.10
Order ref.	63003136.51V

Edge protection/edge sliders for lashing straps



- For the even distribution of lashing forces when lashing down
- Thanks to the integrated slots the edge protection can be fixed on the lashing strap and makes attachment to the cargo easier
- Up to strap width 50 mm
- Material: polyethylene
- Colour: black

Dimensions W x D x H [mm]	110 x 85 x 85
Weight [kg]	0.07
Order ref.	82008008

Load restraint

Long-item tube holder



- Holder for storing long parts
The clamping range of the holder can be set individually using the included lashing strap and the holder roll



Version	Holder	Cone	Cone
Dimensions W x D x H [mm]	125 x 50 x 45	55 x 55 x 41	75 x 75 x 41
Weight [kg]	0.31	0.07	0.05
Order ref.	63003090.19V	63003075.90V	63003076.90V



Load restraint

Internal ladder holder



- For installation on the roof liner to save space in the vehicle
- Suitable for ladders with a length of 2 m, a maximum total step depth of 180 mm and a weight up to 20 kg
- Extension kit can be ordered for ladder lengths of more than 2 metres
- Adjustment to ladder length possible
- Both ladder holder brackets can be folded upwards if not used
- Material: aluminium / painted steel

Version	Internal ladder holder	Extension kit
Dimensions W x D x H [mm]	210 x 1810 x 120	-
Weight [kg]	8.50	1.00
Order ref.	73508060.19V	73508061.19V

Ladder holder, 3-piece



- 3-piece, for single section and double extension ladders
- Attaches to vehicle roof spar by means of a central folding mechanism
- Colour: anthracite grey (RAL 7016)



Version	Suitable for use with ladder spars from 70 to 100 mm	Suitable for use with ladder spars from 130 to 160 mm
Dimensions W x D x H [mm]	46 x 300 x 130	46 x 300 x 190
Net weight [kg]	1.70	1.90
Order ref.	63003083.19V	63003084.19V

Load restraint

Shoring pole holder set



- For secure and space-saving storage of 2 to 4 shoring poles
- Suitable for both versions of the shoring poles
- For mounting onto the lashing rails on the vehicle side wall or in the roof area
- Powder coated sheet steel
- Colour: anthracite grey (RAL 7016)

Version	for 2 shoring poles	for 4 shoring poles
Dimensions W x D x H [mm]	85 x 75 x 120	85 x 75 x 270
Net weight [kg]	0.93	2.05
Order ref.	63003086.19	63003087.19

Adjustable shoring pole plus

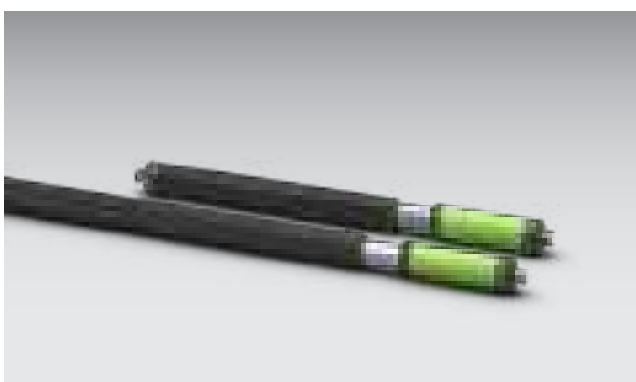

- Used to secure large items in transit
- Telescopic bar can be shortened or extended quickly without tools
- Simple operation by means of Twist Lock when inserting.
- Shoring pole is not spring loaded so there is never any clamping force applied to the roof or the side wall
- Suitable for horizontal and vertical applications
- Equal contact area across the entire length
- Continuous, uniform diameter of the clamping bar that always ensures flat contact surface with transported goods
- Circumferential rubber coating for increased slip-resistance as well as additional protection for the load.

Shoring pole length [mm]	650-800	800-1100	1000-1500	1400-2100	1700-2500
Blocking capacity BC [daN]	650 - 500 daN	700 - 600 daN	725 - 400 daN	500 - 275 daN	425 - 175 daN
Weight [kg]	1.82	2.26	2.84	3.71	4.29
Order ref.	85001118	85001119	85001120	85001121	85001122

Load restraint accessories

Shovel and tool holder for the rear doors



- For the clean secure storage of shovels and similar tools with handles
- Easy cleaning thanks to individually removable dirt catch pan
- Simple and fast load restraint thanks to C-Lash lashing strap
- Rear panel with perfo perforated panel for attaching perfo hooks for fixing the tools
- Incl. 10x perfo hooks (5x length 100 mm / 5x length 150 mm)
- Incl. bracket for installation
- Material: anodised aluminium

Dimensions W x D x H [mm]	506 x 220 x 1545
Weight [kg]	7.80
Order ref.	73502065.97V

Snap fastener



- For fast and secure mounting of small and long parts
- Material: Zinc-plated steel
- Tensioning strap: Plastic, black

Version	Short rubber strap	Long rubber strap
Dimensions W x D x H [mm]	150 x 40 x 40	150 x 40 x 40
Weight [kg]	0.14	0.14
Order ref.	63003041.51V	63003042.51V

Load restraint accessories

Over-centre fastener 60-80 mm



- For installation directly on the SLF in the 25mm pitch and on the SLF panel with steel SLF support strut
- Installation on a bott lashing rail with sliding block order ref. 91002009 screw length 16mm
- Material: zinc-plated steel, rubber strap EPDM black, handle coating PVC

Dimensions W x D x H [mm]	120 x 92 x 45
Weight [kg]	0.33
Pack of	1
Order ref.	73003012.51V

Broom and tool holders



- For assembly on the vehicle roof (vehicle rib or lashing rail), at the side on the SLF and on the lashing rail on the vehicle bulkhead
- A snap fastener is included in the scope of supply and has to be assembled
- The brackets can also be ordered separately
- Protection of the secured devices by PVC coating on the brackets
- Securing of devices with different diameters by means of snap fastener
- Sheet steel zinc-plated or KTL coated PVC black glossy

Version	Broom and tool holder kit	Holder open	Holder closed
Dimensions W x D x H [mm]	-	80 x 80 x 90	
Weight [kg]	1.00	0.33	0.40
Order ref.	73508056.90V	73508057.90V	73508058.90V

Load restraint accessories

Holder for plate compactor with lashing strap

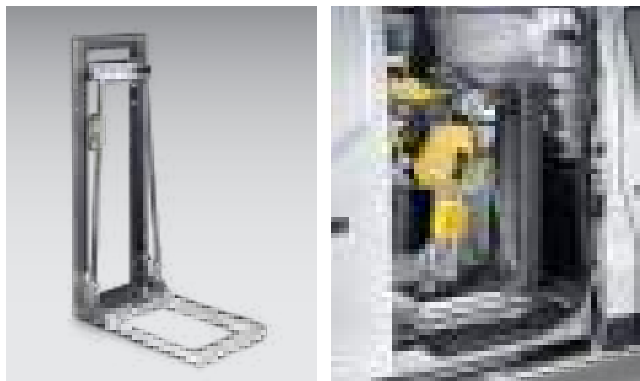

- For the secure transportation of plate compactors in vans or on a flatbed
- Will accommodate a plate size of W x D: 280 x 330-350 mm
- Handle height is adjustable
- Incl. lashing strap

Dimensions W x D x H [mm]	315 x 560 x 930
Weight [kg]	10.40
Order ref.	07002234.19

Lashing strap bag



- Ideal for vehicles with bott vario3 van racking

System depth FE	376
Dimensions W x H [mm]	300 x 265
Weight [kg]	0.35
Order ref.	14014066

Load restraint accessories

Systainer³ Organizer M89 load restraint case with fitting



- Ideal for vehicles with bott vario3 in-vehicle equipment with integrated lashing points and/or lashing rails
- The use of lashing straps with fittings allows transported goods to be secured in a fast and reliable way using the lashing points or lashing rails of the vehicle
- Set consisting of:
 - 1x Systainer³ Organizer M 89
 - 2 x lashing strap 3.5 m with fitting and cam buckle
 - 2 x lashing strap 3.5 m with fitting and ratchet
 - 6x load restraint pad
 - 6x strap protection pad
- Including important information on load restraint

Dimensions W x D x H [mm]	396 x 296 x 89
Weight [kg]	3.66
Order ref.	72610038.19V

Systainer³ Organizer M89 load restraint case with hook



- Ideal for vehicles with bott vario3 in-vehicle equipment with integrated lashing points and/or lashing rails
- The use of lashing straps with fittings allows transported goods to be secured in a fast and reliable way by means of the lashing points or lashing rails of the vehicle
- Set consisting of:
 - 1x Systainer³ Organizer M 89
 - 2 x lashing strap 3.5 m with fitting -oo- and cam buckle
 - 2 x lashing strap 3.5 m with fitting -oo- and ratchet
 - 6x load restraint pad
 - 6x strap protection pad
 - 4x fitting with bott logo 500 daN
- Including important information on load restraint

Dimensions W x D x H [mm]	396 x 296 x 89
Weight [kg]	3.66
Order ref.	72610039.19V

Load restraint accessories

Tiltbox with lashing straps



- Ideal for vehicles with bott in-vehicle equipment including lashing components and/or lashing rails
- The use of lashing straps with fittings allows transported goods to be secured in a fast and reliable way by means of the lashing points or lashing rails of the vehicle
- Set consisting of:
 - 1 bott TiltBox
 - 2 Lashing strap 3.5 m with fitting (-oo-) and cam buckle
 - 2 Lashing strap 3.5 m with fitting (-oo-) and ratchet
- Including important information on load restraint

Dimensions W x D x H [mm]	304 x 147 x 196
Weight [kg]	2.66
Order ref.	72610040.19V

Hydrant key holder



- bott vario3 hydrant key storage solution
- Hydrant key holder is installed on the side of the SLF (depth 2 and 3)
- Snap fastener is included and has to be assembled
- For depth 3, a second snap fastener can be ordered in addition and assembled

System depth	/2		/3	
Dimensions W x D x H [mm]	36 x 264 x 70		36 x 376 x 70	
Weight [kg]	0.47		0.64	
Order ref.	73508048.19M	73508048.19V	73508047.19M	73508047.19V

Load restraint accessories



Your load space can do more

Your vehicle is nothing other than an extension of your home business – thanks to our accessories you can equip it with all the functions and amenities you need when you are on the road. Our range of accessories can roughly be divided into things that turn your vehicle into a mobile workstation and things that open up new kinds of use for storage space.

No matter whether you need your vehicle more as a mobile workshop or a mobile office, the following pages will give you an insight into the possibilities we offer. From fold-out workbench to document holders there are a lot of items available. And if there is anything you feel is missing, please remember that this brochure is only presenting a selection of our comprehensive product range – you are very welcome to contact us for a detailed consultation.





The perfo hole pitch – flexibility built in

The square punched pattern in your racking is not just for decoration. It allows hooks, tool holders, and a wide range of other accessories to be securely fixed in place. The perfo hole pitch is used across all bott product lines to provide maximum flexibility - whether in van racking systems, workshop equipment or workstation systems.

bott. mastering space and time.

Folding worktop

Folding worktop

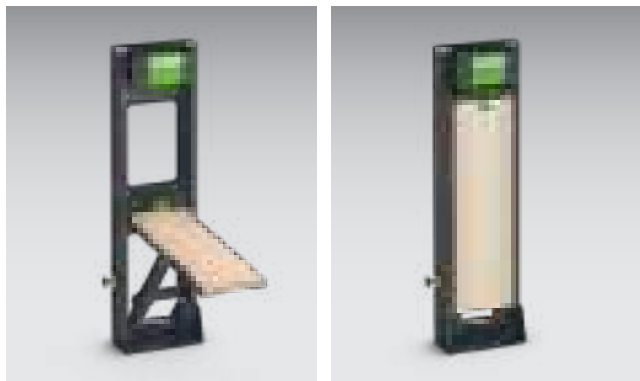

- For working with materials outside of the vehicle
- Cross-laminated beech multiplex worktop, natural finish, oiled
- Suitable for vices with jaw width of maximum 125 mm

Version	Incl. turntable and vice - jaw width 125 mm	Incl. vice - jaw width 125 mm	Without vice
Dimensions W x D x H [mm]	240 x 285 x 895	220 x 285 x 895	125 x 285 x 895
Net weight [kg]	25.63	24.77	12.14
Assembled/packed	Packed	Packed	Packed
Order ref.	71220044.19V	71220043.19V	71220042.19V

Fixing kit for hinged worktop



- For free-standing installation

Dimensions W x D x H [mm]	95 x 60 x 300
Weight [kg]	1.87
Order ref.	73510056.19V

Heavy duty worktop

Folding heavy duty worktop



- Folding heavy-duty worktop incl. stable support leg for heavy work
- Folding mechanism supported by 2 gas pressure springs
- Adjustable work height 775-1015 mm
- Suitable for all bott vices up to a jaw width of 175 mm (turntable only up to jaw width of 150 mm)

Version	Heavy-duty worktop	Heavy-duty worktop with turntable and vice
Dimensions W x D x H [mm]	230 x 270 x 1100	385 x 270 x 1100
Weight [kg]	24.30	44.20
Assembled/packed	Packed	
Order ref.	61220024.51V	61220029.51V

Version	Heavy-duty worktop - low variant	Heavy-duty worktop - low variant incl. turntable and vice S-150
Dimensions W x D x H [mm]	230 x 270 x 975	385 x 270 x 975
Weight [kg]	23.00	42.90
Assembled/packed	Packed	
Order ref.	71220061.51V	71220062.51V

Support leg with snap fastener



- For use with folding and pull-out worktops
- Continuous height adjustment from 730 - 1355 mm
- Secured at chosen height with clamping handle
- Snap fastener

Dimensions W x D x H [mm]	600 x 600 x 650
Weight [kg]	2.40
Order ref.	11425002

Vices

Vices

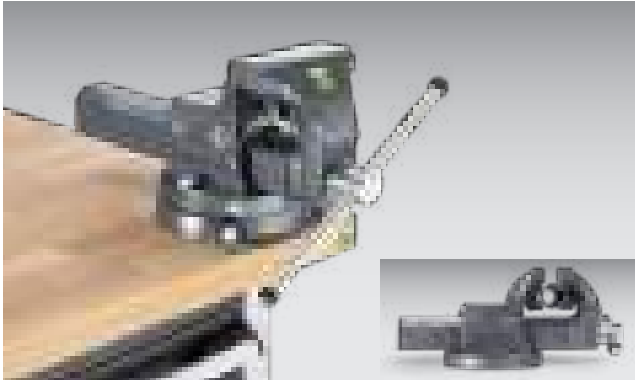

- Forged steel vices
- Hardened jaw and anvil
- Standard model includes 2 additional pipe clamping jaws for securely clamping pipes
- Adjustable guides, scraper keeps guide rails dirt-free
- Vices can be combined with a turntable, height adjuster (except jaw width 175 mm) and collapsible lift (only jaw width 120 mm)
- Colour: anthracite grey

Jaw width [mm]	100	120	135	150	175
Jaw depth [mm]	60	75	85	100	105
Dimensions W x D x H [mm]	120 x 300 x 117	150 x 300 x 144	160 x 430 x 170	180 x 480 x 188	210 x 520 x 208
Order ref.	80601019.19V	80601020.19V	80601021.19V	80601022.19V	80601023.19V

Turntable for vice



- Forged steel turntable for vice
- Tilt-clamp lever for easy adjustment (360° rotation possible)
- With fixing kit
- Colour: anthracite grey

For vice with jaw width [mm]	100	120	135	150	175
Order ref.	80610005.19V	80610006.19V	80610007.19V	80610008.19V	80610009.19V

Protective vice jaws for vice



- Robust plastic for holding sensitive surfaces carefully
- With magnetic strips inserted on the inside for secure hold on the vice jaw
- One outer side with horizontal and vertical V shaped grooves for holding round parts in place, other outer side smooth
- Delivery: in pairs
- Colour: yellow

For vice with jaw width [mm]	100	125	150
Order ref.	80602001.90V	80602002.90V	80602003.90V

Floor vent



- Provides floor level ventilation when transporting compressed gas cylinders
- Plastic: anthracite
- Necessary cut-out Ø 89 mm
- Cut-out for cover on the wooden vehicle floor Ø 89 mm
- With DEKRA certificate

Version	Ventilation element with logo
Dimensions W x D x H [mm]	110 x 110 x 100
Net weight [kg]	0.15
Order ref.	63502055.19V

Ventilation

Roof- or side-mounted vent



- Provides roof or side ventilation when transporting compressed gas cylinders
- Plastic: black
- For cut-out Ø 54 mm
- Low-profile design means vehicle can still be cleaned in a car-wash
- Incl. fixing clip
- With DEKRA certificate

Version	Venting element with logo
Dimensions W x D x H [mm]	94 x 140 x 40
Net weight [kg]	0.20
Order ref.	63502054.10V

Floor vent square



- Provides floor -level ventilation when transporting compressed gas cylinders
- Sheet steel, galvanised
- With square section duct and water deflection plate
- Requires 130 x 130 mm cut-out
- The fan has a free cross-section of at least 100 cm² and thus complies with the requirements for transporting gas bottles in enclosed motor vehicles according to information sheet DVS 0211 and DGUV 210-001

Dimensions W x D x H [mm]	164 x 164 x 80
Weight [kg]	1.10
Order ref.	08032021

Ventilation

Roof- or side-mounted vent



- For venting in the roof and side area when transporting compressed gas bottles
- Plastic: black
- Requires 76 x 216 mm cut-out
- Low-profile design means vehicle can still be cleaned in a car-wash
- The fan has a free cross-section of at least 100 cm² and thus complies with the requirements for transporting gas bottles in enclosed motor vehicles according to information sheet DVS 0211 and DGUV 210-001

Version	Venting element with logo
Dimensions W x D x H [mm]	205 x 355 x 50
Weight [kg]	0.80
Order ref.	80833215.10V

Floor vent rectangular



- For venting at floor level
- when transporting compressed gas bottles
- Stainless steel venting grille
- With square section duct and water deflection plate
- Requires 250 x 72 mm cut-out

Dimensions W x D x H [mm]	280 x 122 x 90
Weight [kg]	1.20
Order ref.	08012022

Ventilation

Cover grille rectangular

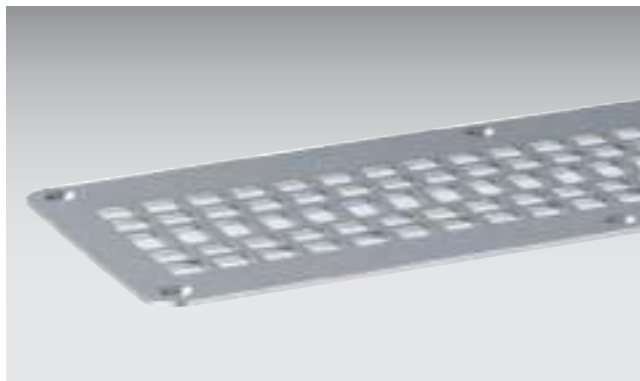

- For venting at floor level when transporting compressed gas bottles
- Stainless steel venting grille
- Can be mounted lengthwise or crosswise
- Requires 250 x 72 mm cut-out

Dimensions W x D x H [mm]	280 x 122 x 2
Weight [kg]	0.36
Order ref.	08012021

Air vent side wall

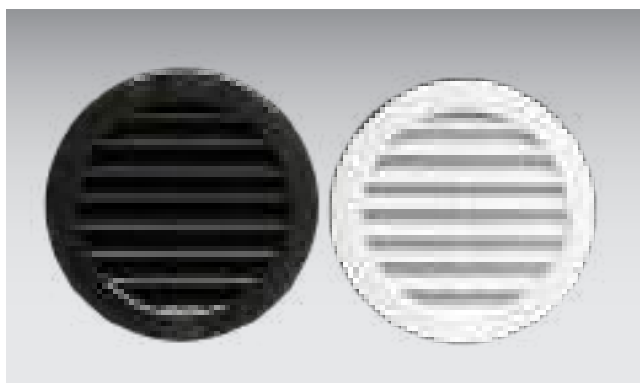

- Provides side ventilation when transporting compressed gas cylinders

Version	Colour: black	Colour: white
Dimensions W x D x H [mm]	150 x 20 x 150	150 x 20 x 150
Net weight [kg]	0.10	0.10
Order ref.	80833019	80833018

Accessories

Compact jerry can 5 L with holder



- A wide variety of liquids can be stored and filled up in a very tight place.
- With upright readable litre scale and drain tap.
- The container can be optimally attached to the bott vario3 van racking system with the holder.
- Optimised outlet for consistent emptying.
- Robust design thanks to the ribbing and thick walls.
- Material: PP / PP+PE / painted steel

Dimensions W x D x H [mm]	108 x 367 x 337
Weight [kg]	1.80
Order ref.	73508081.19V

Compact container



- Compact jerrycan 12 L
- Pack of 1
- Large opening with DIN 96 screw cap
- Small spout opening and 3/4" cap on the rear
- Can be emptied completely
- Material: food-safe polyethylene

Dimensions W x D x H [mm]	410 x 125 x 260
Weight [kg]	0.58
Order ref.	02509011

Accessories

Front loading deposit safe



- Safe for securely transporting money and valuables in the vehicle
- The drop safe cannot be opened by the driver; the contents are removed at the main office
- Security lock with puncture protection
- Deposit drawer with anti-tamper protection
- Colour: anthracite grey (RAL 7016)

Dimensions W x D x H [mm]	405 x 341 x 655
Weight [kg]	40.00
Order ref.	60018003.19

Safe



- Safe for securely transporting money and valuables in the vehicle
- For vertical or horizontal use
- Security lock with puncture protection
- Colour: anthracite grey (RAL 7016)

Dimensions W x D x H [mm]	420 x 400 x 200
Weight [kg]	18.00
Order ref.	60018005.19

Storage hook 37 mm



- Sturdy steel hook for universal installation in the vehicle or on the bott vario3 in-vehicle equipment
- Optimum protection of the stored goods and reduced noise development thanks to rubber-coated contact area
- Diameter of the screw holes: 6.5 mm

Version	Storage hook 37 mm
Dimensions W x D x H [mm]	26 x 59 x 110
Weight [kg]	0.10
Order ref.	14001184.10V

Storage hook 87 mm



- Sturdy steel hook for universal installation in the vehicle or on the bott vario3 in-vehicle equipment
- Optimum protection of the stored goods and reduced noise development thanks to rubber-coated contact area
- Diameter of the screw holes: 6.5 mm

Version	Storage hook 87 mm
Dimensions W x D x H [mm]	26 x 110 x 140
Weight [kg]	0.15
Order ref.	14001185.10V

Accessories

Double hook for clothes

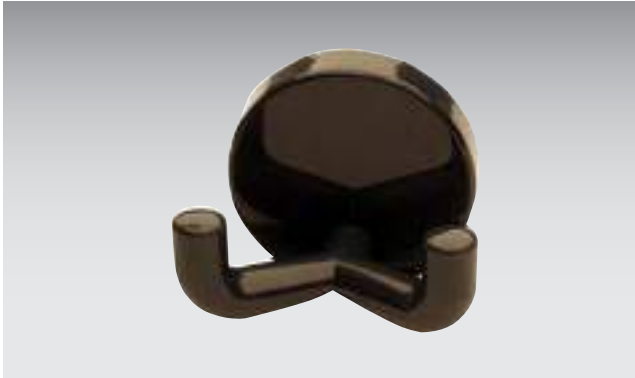

- Double clothes hook
- Maximum load capacity approx. 30 kg
- Material/colour: polyamide, anthracite

Dimensions W x D x H [mm]	50 x 50 x 44
Weight [kg]	0.06
Order ref.	85001105

Swivel hook



- For installation in the SLF groove system, or for free installation in the vehicle
- The swivel hook does not project beyond the front shelf height when swivelled in
- Swivel hook with rotation to left/right/centre
- Optimum protection for the loaded goods thanks to rubber-coated surface, anti-slip and noise-damping
- Different support depths 91 mm/ 141 mm
- Load capacity support depth 91 mm: 10 kg
- Load capacity support depth 141 mm: 8 kg
- Zinc-plated with rubber coating
- RAL 6018

Dimensions W x D x H [mm]	29 x 123 x 126	29 x 173 x 126
Weight [kg]	0.13	0.17
Order ref.	73003005.17V	73003006.17V

Accessories

bott heavy duty hook



- Ideal for hanging up tools or different materials
- Load capacity 40 kg
- Rubber-coated contact area
- Contact area 110mm
- Perforation suitable for hole patterns for bott vario3, avero and perfo

Dimensions W x D x H [mm]	24 x 154 x 280
Weight [kg]	0.36
Order ref.	14001188.10V

Folding table fitting

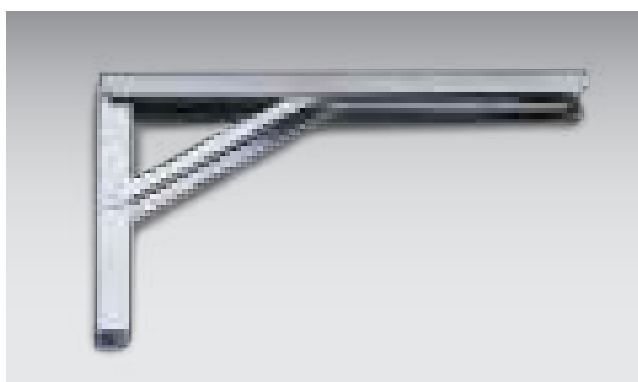

- Zinc-plated steel
- Used to create folding work surfaces
- 3-position angle adjustment
- Load capacity 200 kg



Dimensions W x D x H [mm]	30 x 300 x 200	36 x 400 x 270
Weight [kg]	0.60	1.14
Order ref.	08010013	08010014

Accessories

Document holders



- Anodised aluminium
- For document storage or other equipment

Version	Long items	Long items	DIN first-aid kits	DIN A4 portrait	DIN A4 (angled)
Dimensions W x D x H [mm]	114 x 114 x 500	76 x 76 x 500	175 x 93 x 230	215 x 85 x 275	256 x 300 x 300
Weight [kg]	0.82	0.75	0.40	0.50	0.42
Order ref.	62530004.97V	62530005.97V	62530003.97V	62530001.97V	62530006.97V

bott vario3 spray can holder, angled

- suitable for bott vario3 vehicle equipment for mounting on the SLF
- Powder-coated sheet steel
- Colour: anthracite grey (RAL 7016)



Version	For cartridges up to max. ø 50 mm
Dimensions W x D x H [mm]	100 x 230 x 159
Weight [kg]	0.40
Pack of	1
Order ref.	72530002.19V

bott vario3 spray can holder, angled

- suitable for bott vario3 vehicle equipment for mounting on the SLF
- Powder-coated sheet steel
- Colour: anthracite grey (RAL 7016)



Version	For cans up to max. ø 68 mm
Dimensions W x D x H [mm]	100 x 230 x 159
Weight [kg]	0.36
Pack of	1
Order ref.	72530003.19V

File holder

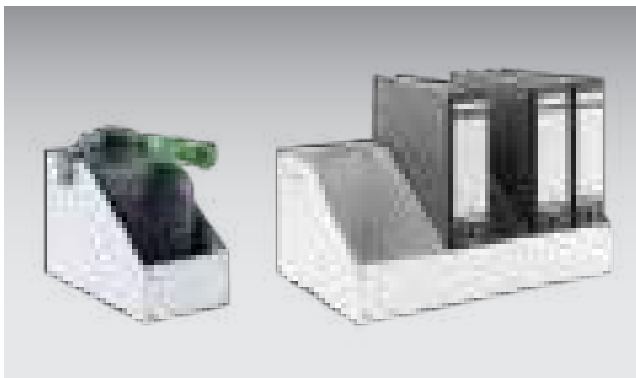

- Suitable for 2 or 6 DIN A4 ring binders, width 80 mm
- Anodised aluminium
- Dividers (optional)

Version	for 2 ring binders	for 6 ring binders	Dividers (pair)
Dimensions W x D x H [mm]	163 x 311 x 215	496 x 311 x 215	284 x 218 x 16
Net weight [kg]	0.80	1.48	0.33
Order ref.	63003004.97V	63003005.97V	63003006.97V

Jerrycan compartment

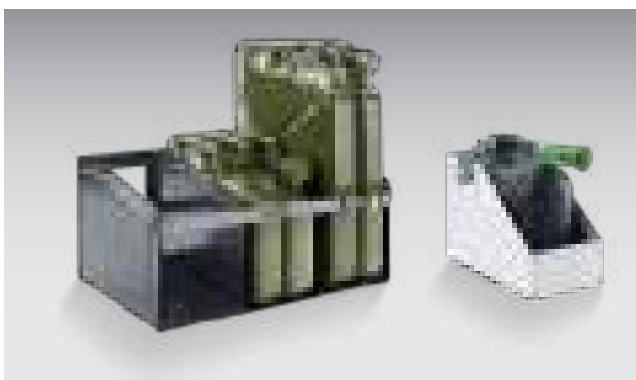

- Suitable for 5 L plastic fuel cans or 10 L/20 L sheet steel fuel canisters
- For 5 L cans: made of anodised aluminium
- For 10 L and 20 L jerrycans: made of powder-coated sheet steel RAL 7016
- Incl. cam buckle strap with self-locking buckle for securing jerrycans while driving

Version	1x 5 L	1x 10 L/20 L	3x 10 L/ 20 L
Dimensions W x D x H [mm]	163 x 311 x 215	173 x 342 x 243	518 x 342 x 243
Net weight [kg]	0.90	2.90	3.60
Order ref.	63003007.97V	63003008.19V	63003009.19V

Accessories

Storage box



- For the storing of small parts and required materials
- For installing on bott vario3 end frames
- Incl. Fixing kit
- Powder-coated sheet steel
- Colour: anthracite grey (RAL 7016)

Dimensions W x D x H [mm]	100 x 376 x 100	100 x 488 x 100
Usable width [mm]	97	
Usable depth [mm]	363	475
Weight [kg]	1.15	1.39
Order ref.	73003002.19V	73003003.19V

bott vario3 battery holder



- Holder for battery variants Makita, Bosch, Milwaukee, Festool and Dewalt
- Holder can be attached to bott vario3 SLF, it is also possible to attach the battery holder to a perfo panel
- Material: powder coated steel (RAL 7016)

Suitable for	Makita/Bosch		Milwaukee/Festool/Dewalt	
Dimensions W x D x H [mm]	30 x 254 x 65	30 x 366 x 65	30 x 254 x 65	30 x 366 x 65
Weight [kg]	0.35	0.49	0.38	0.53
Order ref.	72530006.19V	72530007.19V	72530008.19V	72530009.19V

Document holder



- Easy clip-on plastic holder for DIN A4 landscape format
- Incl. colour coded label strip and fixing kit

DIN Format	A4 landscape
Dimensions W x D x H [mm]	340 x 100 x 213
Weight [kg]	1.90
Pack of	5
Order ref.	14014029.19

Cable winder SLF



- Cable winder for side installation via the adapter plate on the SLP panel or SLF plus R
- Incl. safety catch
- Fixing in 25mm height increment
- Optimum installation position designed for system depths 376/3 and 488/4
- Cable length: 10m / with Schuko plug

Version	Cable winder
Dimensions W x D x H [mm]	400 x 165 x 300
Weight [kg]	6.50
Order ref.	73508026.19V

Accessories

Vertical holder



- With integrated clamp unit
- For securing systainer³ in the vehicle
- Suitable for systainer³ M+ L
- Max. stacking height 870 mm
- For installation on vehicle floor and wall

Dimensions W x D x H [mm]	380 x 125 x 1000
Weight [kg]	2.70
Order ref.	73003004.19V

Vertical holder for disposable gloves



- Glove boxes made of robust metal
- Disposable gloves always within reach
- Easy installation
- Holder can be used for various bott application possibilities
- Painted steel

Dimensions W x D x H [mm]	133 x 47 x 145
Weight [kg]	0.19
Order ref.	72530005.19V

Chainsaw holder for flatbeds



- Comprising of 2 solid core mounts incl. fixing bracket
- Can be shortened for smaller system widths
- L-Profiles, flooring panels and drop fronts must be planned separately

Dimensions W x D x H [mm]	1486 x 169 x 95
Weight [kg]	4.50
Order ref.	72107023.10V

bott vario CarOffice



- Practical way to store office supplies
- Ensures order in the passenger seat
- With two holders for brochures, catalogues and other documents
- A storage box for small parts that can be quickly removed
- A folding, non-slip writing pad with magnetic holder and built-in cylinder holder
- Simple and secure mounting on the passenger seat with the seat belt and a variably adjustable headrest adapter

Dimensions W x D x H [mm]	340 x 520 x 690
Weight [kg]	4.90
Order ref.	63003098.19V

Accessories

bott vario VanOffice

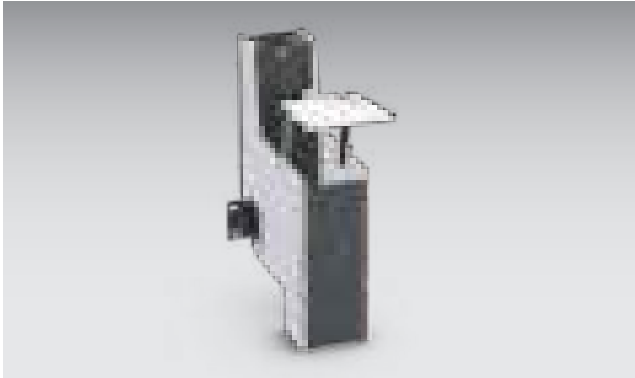

- Centre console in the front passenger area can be used as a storage compartment or desk for storing various everyday items
- Creates additional storage space in the passenger compartment
- Enables clear and organised storage of various items

Suitable for	Mercedes Vito	VW ID. Buzz	Ford Transit Custom/VW New Transporter
Dimensions W x D x H [mm]	180 x 512 x 658	182 x 526 x 657	150 x 500 x 615
Weight [kg]	8.15	9.00	
Order ref.	73003008.19V	73003014.19V	73003015.19V

bott vario VanOffice SL



- Centre console in the passenger compartment, usable as shelf, writing desk and storage space for various practical items
- Creates extra storage space in the passenger compartment
- Facilitates neat and tidy stowage for different objects
- Fixings for Mercedes Benz Sprinter
- Colour: RAL 7016

Version	bott vario VanOffice SL	Fixings Mercedes Benz Sprinter
Dimensions W x D x H [mm]	270 x 412 x 626	-
Weight [kg]	9.91	0.92
Order ref.	70001004.19V	73502104.19V

Accessories

Sulo waste bin with holder



- Waste bin with 10L capacity
- Metal carry handle, can be inserted into the holder
- Installation possibility on SLF, lashing rail, rear door, protect plus or VPP

Dimensions W x D x H [mm]	245 x 295 x 309
Weight [kg]	0.97
Order ref.	73508046.19V

Hose holder



- For storage of hoses and cables
- Made of die-cast aluminium

Version	Hose holder S	Hose holder M	Hose holder L	Hose holder X
Dimensions W x D x H [mm]	190 x 70 x 145	265 x 105 x 200	350 x 145 x 255	415 x 190 x 305
Weight [kg]	0.29	0.48	1.14	2.38
Order ref.	14050001	14050002	14050003	14050004

Accessories

Folding seat with cushion/fixing bracket



- Powder-coated sheet steel
- Colour: anthracite grey (RAL 7016)
- Upholstered cushion
- Seat height from 325 – 425 mm
- Automatically folding support leg with gas spring support
- For mounting on an end frame or a wall mount
- Seat height adjustable in 25 mm increments on wall mount
- Powder-coated sheet steel
- Colour: anthracite grey (RAL 7016)
- With wall mount to put the folding seat in place when no end-frame is available

Version	Folding seat	Wall mount
Dimensions W x D x H [mm]	300 x 80 x 650	236 x 85 x 650
Weight [kg]	10.60	3.20
Order ref.	73003009.19V	73003010.19V

Spirit level holder



- For transporting long parts such as spirit levels or straightedges
- For installation on bott vario3 trays and long item top trays
- With hook and loop fastener and fixing bolts
- Pack of 2
- Powder-coated sheet steel
- Colour: anthracite grey (RAL 7016)

Dimensions W x D x H [mm]	94 x 32 x 58
Weight [kg]	0.40
Order ref.	73508001.19V

Accessories

Guide rail storage brackets for portable circular saws



- Used to install guide rails for hand-held circular saws
- Can be attached to the SLF T-nut, to lashing rails or to perfo panels
- With holder bracket on the left and right side, each fitted with adhesive tape
- For Festool, Bosch and Makita guide rails
- Painted steel RAL 7016

Dimensions W x D x H [mm]	85 x 36 x 189
Weight [kg]	0.70
Order ref.	73508079.19V

Grab handle 90°



- For safe entry into the vehicle
- For installation inside side or rear doors
- Hole spacing 408 mm
- Colour: yellow-green (RAL 6018)

Version	yellow-green
Dimensions W x D x H [mm]	38 x 74 x 430
Net weight [kg]	0.40
Order ref.	80701007.17

Accessories

Entry grab handle



- To safely enter the vehicle
- For installation near the sliding or rear doors
- For flexible installation on the SLF
- Hole spacing 417 mm
- Suitable for VW T6, Citroën Jumpy, Peugeot Expert, Toyota ProAce (2016) (Y54), Opel Vivaro (2019), Fiat Scudo (2022) (Y57), MB Sprinter (Y66), VW Crafter, MAN TGE (Y58)
- Colour: yellow-green (RAL 6018)

Dimensions W x D x H [mm]	23 x 76 x 448
Net weight [kg]	0.44
Order ref.	80701009.17

ABC-powder extinguisher



- ABC powder extinguisher acc. to DIN EN 3
- Secured against unintended use
- Approx. 4 m effective range
- One-handed operation
- Incl. holder for mounting in vehicle

Version	With internal propellant gas bottle - 1 kg	Constant pressure device - 2 kg	Constant pressure device - 6 kg	Constant pressure device - 12 kg
Dimensions W x D x H [mm]	105 x 160 x 295	115 x 160 x 380	105 x 280 x 540	190 x 280 x 630
Weight [kg]	2.20	4.20	10.35	17.50
Order ref.	63003123.90	63003049.90	63003124.90	63003125.90

Accessories

Case holder for Systainer³, Organizer and varioCase 84



- Suitable for Systainer³, Organizer M/L and varioCase84
- For installation on the upright profiles in system depth 3 and 4
- Additional security against slipping out during transport
- Painted steel
- Colour: anthracite grey (RAL 7016)

From system depth [mm]	376	376
Version	Case holder	Case holder
Dimensions W x D [mm]	100 x 371	100 x 371
Weight [kg]	1.39	1.39
Assembled/packed	Assembled	Packed
Order ref.	72103032.19M	72103032.19V

Storage pocket for Systainer³, Organizer and varioCase 84

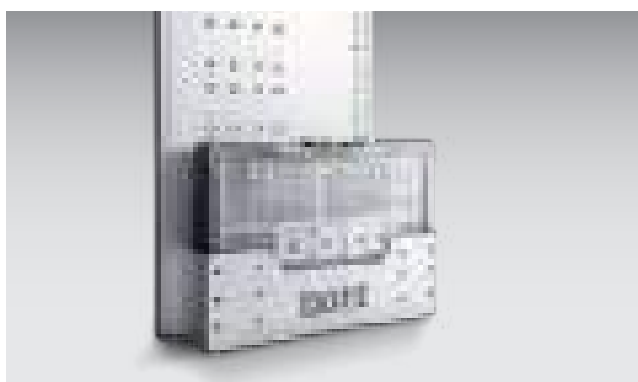

- Suitable for Systainer³, Organizer M/L and varioCase84
- For installation on the upright profiles or on the bott wall rail systems
- Suitable for depth 4 and 5
- anodised aluminium

From system depth [mm]	488	600
Version	for Systainer ³ -Organizer M	for Systainer ³ -Organizer L/varioCase84
Dimensions W x D [mm]	100 x 409	100 x 521
Weight [kg]	0.67	0.82
Order ref.	72103034.97V	72103035.97V

Accessories

Upright storage pocket for Systainer³ M112



- Upright insert holder for Systainer³ M112
- Holder assembly onto standard end-frame profiles (SLF) or lashing rails: a depth strut must be installed behind the central panel
- Fits all system depths
- Colour: painted steel RAL 7016 anthracite grey

Version	Upright
Dimensions W x D x H [mm]	300 x 132 x 105
Weight [kg]	0.79
Order ref.	72103054.19V

Toolbox for flatbeds



- bott tool box for flatbed 500: payload 30kg, volume 30.5l
- bott tool box for flatbed 750: payload 45kg, volume 47.5l
- Protection class IP5K9KE11-R73
- Safe transport under the cargo area - storage space rain- and splashwater-proof
- Material: polypropylene, nylon with high resistance to fire, dust and water, lubricating oils and hydrocarbons, UV beams, high and low temperatures
- VCA-certified as underride protection

Version	For flatbed 500	For flatbed 750	Lock with 2 keys
Dimensions W x D x H [mm]	500 x 350 x 300	750 x 350 x 300	115 x 90 x 120
Weight [kg]	3.00	4.54	0.18
Order ref.	73520003	73520004	73520005

Accessories

bott vario3 storage bag



- Storage bag with hinged cover for light objects or waste
- Installation of the storage bag S at the side on SLF /3
- Installation of the storage bag S + M on the rear door or on the perfo panel at the vehicle bulkhead
- Colour: anthracite grey (RAL 7016)

Dimensions W x D x H [mm]	300 x 120 x 400	450 x 220 x 550
Weight [kg]	0.65	1.15
Order ref.	73508027.19V	73508028.19V

Wheel arch cladding



- Wheel arch cladding with FrontLash -oo- tray with anti-slip mat
- Clear height inside 350/450mm
- Screw attachment matching pitch of floor rails but cannot be integrated in the bott vario3 shelf system
- The wheel arch cladding serves as an overhang for wheel arches in the load space - the TopLash lashing system can be retrofitted to the trays (option)
- Stud plate made of natural aluminium

Dimensions W x D x H [mm]	981 x 266 x 450	981 x 266 x 550	1093 x 266 x 550
Weight [kg]	6.10	6.00	7.00
Assembled/packed	Packed		
Order ref.	11303017.98V	11303015.98V	11303016.98V

Accessories

Aluminium folding stepladder



- 2x 4 steps
- Can be used on both sides
- Robust and impact-proof metal joint connections
- Stable and 6x riveted step/side rail connection for high stability
- Non-slip, profiled end caps which do not mark the floor
- Tear-resistant belt straps
- Max. load capacity 150 kg

Dimensions W x D x H [mm]	450 x 160 x 950
Weight [kg]	3.50
Order ref.	63003132

Traffic cone (collapsible)



- Height while folded: 60 mm
- 2 cones with continuous flashing lights
- Incl. storage bag

Dimensions W x D x H [mm]	280 x 280 x 60	390 x 390 x 750
Weight [kg]	1.80	3.20
Order ref.	85001025	63003077.90V

Storage pocket with 2 cones



- Anodised aluminium storage pocket with 2 cones
- For installing on bott vario3 end frames
- 2 cones with continuous flashing lights
- Cone dimension W x D x H: 280 x 280 x 500 mm
- Incl. storage bag



Version	with 2 cones	Empty
Dimensions W x D x H [mm]	300 x 132 x 310	300 x 132 x 310
Weight [kg]	4.70	1.44
Order ref.	63003122.97V	63003121.97V

Endframe storage tray

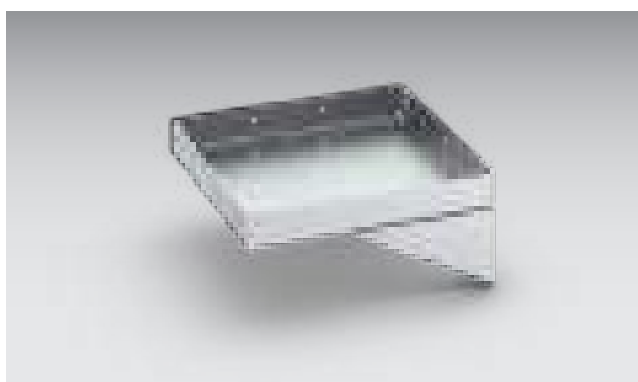

- Shelf for installation at the side on the end frame
- Material: aluminium
- Useful area 264 x 247 mm
- Edge height 33 mm
- Load capacity: 5 kg

Dimensions W x D x H [mm]	266 x 255 x 155
Weight [kg]	0.56
Order ref.	62533404.98V

Accessories

Shelf with anti-slip mat



- For the secure storage of objects with ergonomic removal through simple access
- Installation on the bott vario3 SLF in depth 3 and depth 2 plus R
- Mount incl. anti-slip mat, protective strip on the SLF, 2 single lashing eyes and lashing strap
- Material: painted steel

Dimensions W x D x H [mm]	340 x 145 x 23
Weight [kg]	1.06
Order ref.	72121018.19V

Universal holder for safety helmets



- Universally adjustable for different sizes and shapes
- Optimised for installation on bott vario3 end frames or perforated panels
- Material: Anodised aluminium

Dimensions W x D x H [mm]	256 x 0 x 281
Weight [kg]	0.27
Order ref.	63003130.97

Accessories

Mobile workbench MW1000



- The ideal companion for mobile, semi-stationary work on the construction site
- Transport and mobile storage of systainers, hand tools and consumables
- Outstanding movement over steps thanks to large full-rubber and impact-resistant wheels (diameter: 200mm)
- Adjustable angle on the push handle, sliding surfaces and integral handle on the shelf enable easy loading of the unit into a vehicle by a single person
- Effortless set-up and dismantling and compact dimensions
- Sturdy working area comprising of perforated panel and aluminium profile offers flexible clamping and attachment options
- Dimensions of attached table: 1045 x 500 mm

Dimensions W x D x H [mm]	600 x 641 x 1185
Weight [kg]	31.00
Order ref.	72522042.90V

Workbench holder for MW1000



- For securing a mobile workbench from Festool on the bott perforated panel
- Fixings included
- Painted steel

Dimensions W x D x H [mm]	1000 x 164 x 47
Weight [kg]	2.40
Order ref.	07002262.19V

Accessories

Holder for Systainer³ dolly

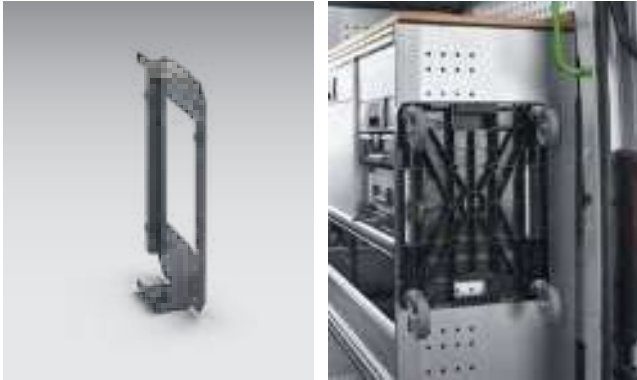

- For the fast, simple and safe storage of the Systainer³ dolly
- Noise reduced by rubber buffers
- For installation at the side on the bott vario3 SLF frames or perforated panels
- Material: powder-coated aluminium (RAL 7016)

Version	Holder for Systainer ³ dolly
Dimensions W x D x H [mm]	290 x 66 x 439
Weight [kg]	0.68
Order ref.	73508025.19V

Aluminium folding ramps



- High-strength and weatherproof aluminium alloy
- Load capacity 370 kg / pair
- For height differences between 400-700 mm
- Runway with highly anti-slip surface (R12)
- Pack of 2

Dimensions W x D x H [mm]	200 x 2535 x 60
Weight [kg]	22.00
Order ref.	63003133

Accessories

Holder for aluminium folding ramps

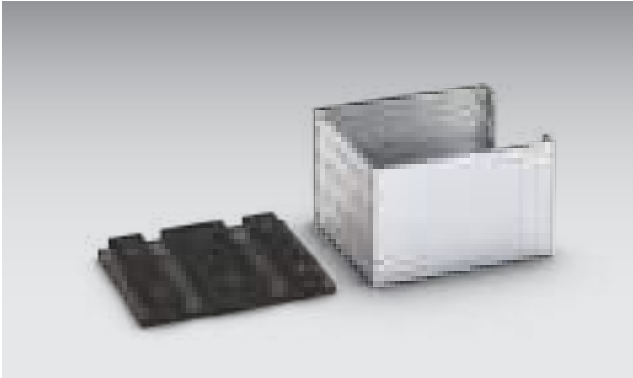

- Suitable for 2 folding ramps made of aluminium
- Material: Aluminium

Dimensions W x D x H [mm]	225 x 243 x 150
Weight [kg]	1.35
Order ref.	63003135.98

Sack truck



- Sturdy aluminium / plastic construction
- Transport platform approx. W 490 x D 270 mm
- Folding base and wheels / telescopic handle
- Incl. rubber strap to secure goods in place
- Max. load capacity = 125 kg

Dimensions W x D x H [mm]	490 x 60 x 755
Weight [kg]	5.10
Order ref.	63003026.90V

Accessories

Holder for folding sack truck



- Suitable for the bott sack truck
- For installing on vehicle bulkheads and bott vario3 end frames
- Fixing kit included
- Material: Sheet steel
- Colour: anthracite grey (RAL 7016)

Version	Sack truck holder
Dimensions W x D x H [mm]	500 x 72 x 80
Weight [kg]	1.20
Order ref.	63502064.19V

Tripod holder



- Long item prism holder for holding tripods and other components
- For free installation on floors or on the side of the SLF
- Long item prism holder with integrated C-Lash lashing strip for fixing transported goods and with felt supports at the side
- Felt support and lashing strap for the careful and secure fixing of tripods
- Variable installation width due to two-part design

Dimensions W x D x H [mm]	208 x 130 x 60
Weight [kg]	0.70
Order ref.	73508039.19V

Accessories

Parts holder



- Holder incl. lashing strap for securing various devices
- Incl. assembly fixings for screwing directly to a bott lashing rail and for free positioning
- Infinitely variable adjustment through sliding block in the bott lashing rail
- Suitable for installation anywhere

Dimensions W x D x H [mm]	125 x 64 x 51
Weight [kg]	0.34
Assembled/packed	Packed
Order ref.	73502007.19V

perfo can and cartridge holder

- Powder-coated steel, anthracite grey RAL 7016
- With 2 locations, max. Ø 70 mm

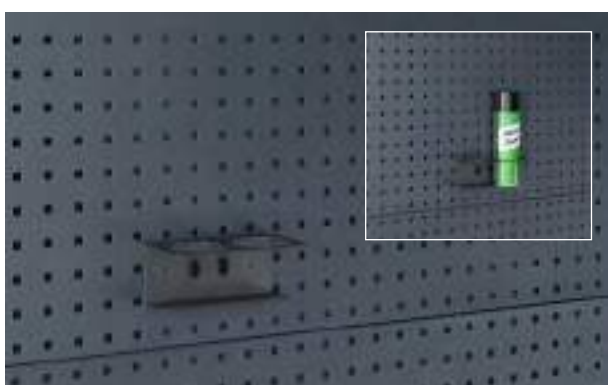

Colour	Anthracite grey
Dimensions W x D x H [mm]	175 x 87 x 70
Weight [kg]	0.39
Pack of	1
Order ref.	14021053.19V

perfo can and cartridge holder, angled

- For cartridges up to max. Ø 50 mm



Colour	Light grey	Anthracite grey
Dimensions W x D x H [mm]	225 x 100 x 165	225 x 100 x 165
Weight [kg]	0.58	0.42
Pack of	1	1
Order ref.	14021054.16V	14021054.19V

Accessories

perfo can and cartridge holder, angled

- For cans up to max. Ø 68 mm

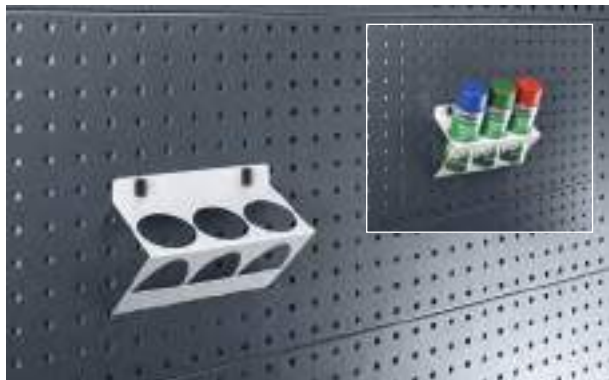

Colour	Light grey	Anthracite grey
Dimensions W x D x H [mm]	225 x 100 x 165	225 x 100 x 165
Weight [kg]	0.58	0.39
Pack of	1	1
Order ref.	14021055.16V	14021055.19V

perfo paper roll holder, self-securing

- For paper rolls with a max. width of 260 mm, Ø 280 mm
- Includes 1 paper roll



Version	Paper roll holder	Paper rolls
Dimensions W x D x H [mm]	315 x 185 x 180	200 x 130 x 130
Max. roll width [mm]	260 mm	
Weight [kg]	1.82	7.14
Pack of	1	12
Order ref.	63003058.19V	63003074.90V

perfo rubbish bag holder 1 - 16 litres

- Made of anodised aluminium
- Including 1 roll of rubbish bags 5 L (50 pieces)



Version	Waste container	1 roll of rubbish bags (50 pieces)
Dimensions W x D x H [mm]	187 x 103 x 275	450 x 450 x 520
Weight [kg]	0.45	0.20
Pack of	1	2
Order ref.	63003105.97	63003106

perfo soap dispenser

- Made of plastic, includes 1 L liquid soap



Version	perfo soap dispenser	1 L liquid soap
Dimensions W x D x H [mm]	100 x 130 x 290	400 x 300 x 120
Weight [kg]	1.50	6.50
Pack of	1	6
Order ref.	02509004	89905002

Accessories

perfo hand towel dispenser

- Made of plastic, includes 1 paper roll



Version	perfo hand towel dispenser	Paper rolls
Dimensions W x D x H [mm]	185 x 170 x 340	200 x 130 x 130
Weight [kg]	1.54	7.40
Pack of	1	12
Order ref.	02509003	89905001

perfo water dispenser set

- 12 L holding capacity
- Dispensing tap on container base
- With aluminium shelf and fixing strap



Dimensions W x D x H [mm]	370 x 173 x 375
Weight [kg]	1.46
Pack of	1
Order ref.	63003059.19V

Hand wash unit 12V

- Max. water temperature 60°C
- With overheat protection
- Incl. cable set, container with securing strap and fixing material



Dimensions W x D x H [mm]	300 x 230 x 525
Weight [kg]	7.00
Pack of	1
Order ref.	50202002

Accessories

Safety label warning strip red and white



- Vehicle safety marking adapted to the vehicle contour at the front, rear and side incl. installation instructions for different vehicles
- Simple and fast adhesion thanks to custom-fit trimming of the contour-related warning marking
- Attachment of red-and-white warning marking should be carried out in accordance with DIN 30710 – Safety marking of vehicles and equipment

Dimensions W x D x H [mm]	564 x 141
Weight [kg]	0.14
Order ref.	84501003

Vehicle safety marking



- Vehicle safety marking adapted to the vehicle contour at the front, rear and side incl. installation instructions for different vehicles
- Simple and fast adhesion thanks to custom-fit trimming of the contour-related warning marking
- Attachment of red-and-white warning marking should be carried out in accordance with DIN 30710 – Safety marking of vehicles and equipment

Version	Citroen Jumper 2006 rear door	Citroen Jumpy 2016 rear door L1	Citroen Jumpy 2016 tailgate
Weight [kg]	0.45	0.45	0.45
Order ref.	84501007	84501017	84501018

Version	Fiat Scudo 2022 rear door L1	Fiat Scudo 2022 tailgate	Fiat Ducato 2024 rear door
Weight [kg]	0.45	0.45	0.45
Order ref.	84501036	84501037	84501070

Accessories

Version	Ford Transit from 2020 rear door	Ford Connect 2022 rear door L1	Ford Connect 2022 tailgate L1	Ford Connect 2022 rear door L2	Ford Connect 2022 tailgate L2
Weight [kg]	0.45	0.45	0.45	0.45	0.45
Order ref.	84501010	84501048	84501050	84501049	84501051

Version	Ford Custom 2023 rear door	Ford Custom 2023 tailgate	Ford Courier 2023 rear door	Ford Transit Flatbed 2020
Weight [kg]	0.05	0.45	0.45	0.45
Order ref.	84501046	84501047	84501068	84501066

Version	Iveco Daily 2014 rear door	Iveco eDaily 2023 rear door
Weight [kg]	0.45	0.45
Order ref.	84501038	84501039

Version	MAN TGE 2017 rear door	MAN TGE Flatbed 2017
Weight [kg]	0.45	0.45
Order ref.	84501020	84501056

Version	Maxus eDeliver 7 2023 rear door
Weight [kg]	0.45
Order ref.	84501052

Version	MB Citan 2021 rear door L1	MB Citan 2021 hatch L1	MB Citan 2021 rear door L2	MB Citan 2021 hatch L2
Weight [kg]	0.45	0.45	0.45	0.45
Order ref.	84501026	84501028	84501060	84501062

Version	MB Vito 2014 rear door	MB Vito 2014 tailgate	MB Sprinter 2018 rear door	MB Sprinter Flatbed 2018
Weight [kg]	0.45	0.45	0.45	0.45
Order ref.	84501013	84501014	84501025	84501069

Version	Nissan Townstar 2022 HT L1 rear door	Nissan Townstar 2022 L2 rear door
Weight [kg]	0.45	0.45
Order ref.	84501072	84501073

Accessories

Version	Opel Combo 2018 rear door L2	Opel Combo 2024 rear door L2	Opel Vivaro 2019 rear door	Opel Vivaro 2019 tailgate
Weight [kg]	0.45	0.45	0.45	0.45
Order ref.	84501022	84501064	84501040	84501041

Version	Opel Vivaro 2024 rear door	Opel Vivaro 2024 tailgate	Opel Movano 2024 rear door
Weight [kg]	0.45	0.45	0.45
Order ref.	84501058	84501059	84501071

Version	Peugeot Expert 2016 rear door	Peugeot Expert 2016 tailgate
Weight [kg]	0.45	0.01
Order ref.	84501042	84501043

Version	Renault Kangoo Rapid 2021 rear door L1	Renault Kangoo Rapid 2021 hatch L1	Renault Kangoo Rapid 2021 rear door L2	Renault Kangoo Rapid 2021 rear door L2
Weight [kg]	0.45	0.45	0.45	0.45
Order ref.	84501027	84501029	84501061	84501063

Version	Renault Trafic 2022 tailgate
Weight [kg]	0.45
Order ref.	84501012

Version	VW T6.1 2019 rear door	VW T6.1 2019 Tailgate	VW Caddy 2020 rear door L1	VW Caddy 2020 tailgate L1
Weight [kg]	0.45	0.45	0.45	0.45
Order ref.	84501015	84501016	84501030	84501032

Version	VW Caddy 2020 rear door L2	VW Caddy 2020 tailgate L2	VW Crafter from 2017 rear door	VW Crafter Flatbed 2017
Weight [kg]	0.45	0.45	0.45	0.45
Order ref.	84501031	84501033	84501019	84501067

Version	VW ID BUZZ 2022 rear door	VW ID BUZZ 2022 tailgate	VW New Transporter 2024 rear door	VW New Transporter 2024 tailgate
Weight [kg]	0.45	0.45	0.45	0.45
Order ref.	84501034	84501035	84501065	84501057

Accessories

Broom and tool holders

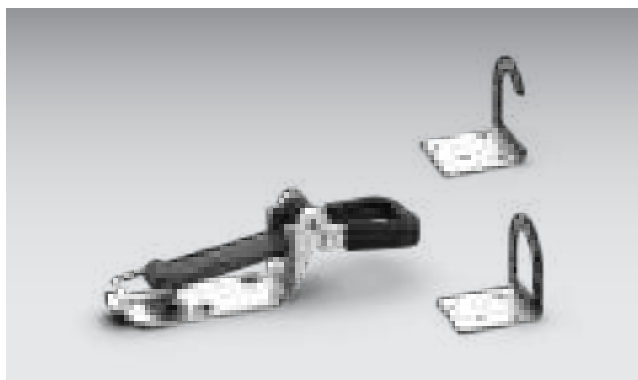

- For assembly on the vehicle roof (vehicle rib or lashing rail), at the side on the SLF and on the lashing rail on the vehicle bulkhead
- A snap fastener is included in the scope of supply and has to be assembled
- The brackets can also be ordered separately
- Protection of the secured devices by PVC coating on the brackets
- Securing of devices with different diameters by means of snap fastener
- Sheet steel zinc-plated or KTL coated PVC black glossy

Version	Broom and tool holder kit	Holder open	Holder closed
Dimensions W x D x H [mm]	-	80 x 80 x 90	
Weight [kg]	1.00	0.33	0.40
Order ref.	73508056.90V	73508057.90V	73508058.90V

